

Polymers



Prof. (Dr.) Radha Tomar

Professor

*School of Studies in Chemistry,
Jiwaji University, Gwalior-India*

Outline

- **Introduction**
- **Classification of Polymers**
- **Kinetics of Polymerization**
- **Number-average Concept**
- **Weight-average Concept**
- **Methods of Molecular mass determination**

Polymers - What are they?

- Polymers are a special kind of macromolecules.
- The word polymer comes from the Greek words “poly,” meaning “many”, and “meres,” meaning “parts” or “repeating units”
- A Polymer consists of a large chain of repeating molecules (monomers) that are attached in an end to end fashion.

- Well known examples of Polymers include plastics, DNA and proteins. E.g.- **Polyethylene** (PE), **Poly vinyl chloride** (PVC) **Polypropylene** whose repeating unit structures are shown below.

“Poly”
many
“mer”
repeat unit

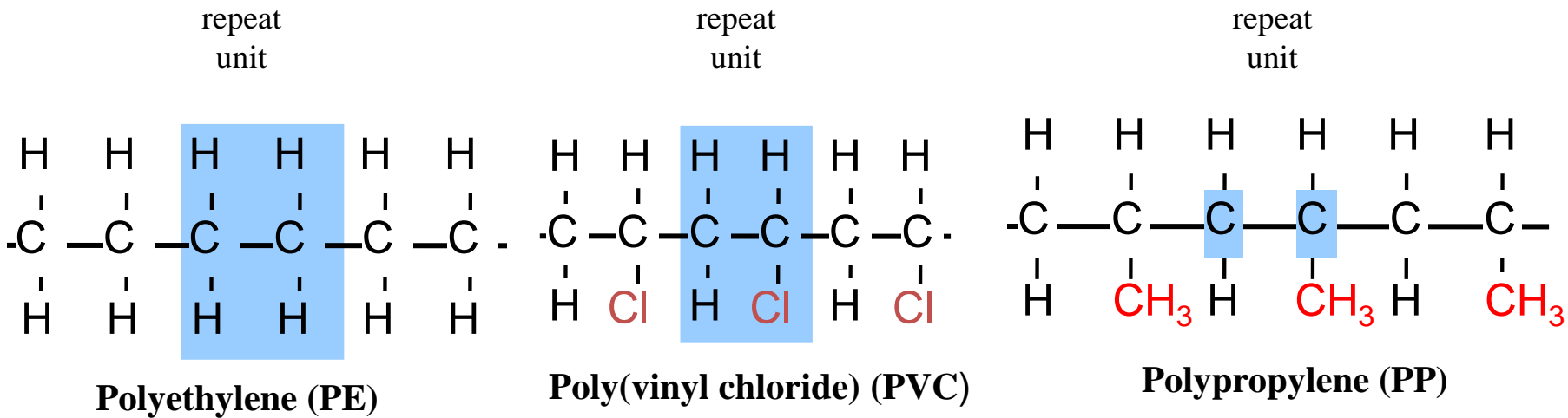

CLASSIFICATION OF POLYMER

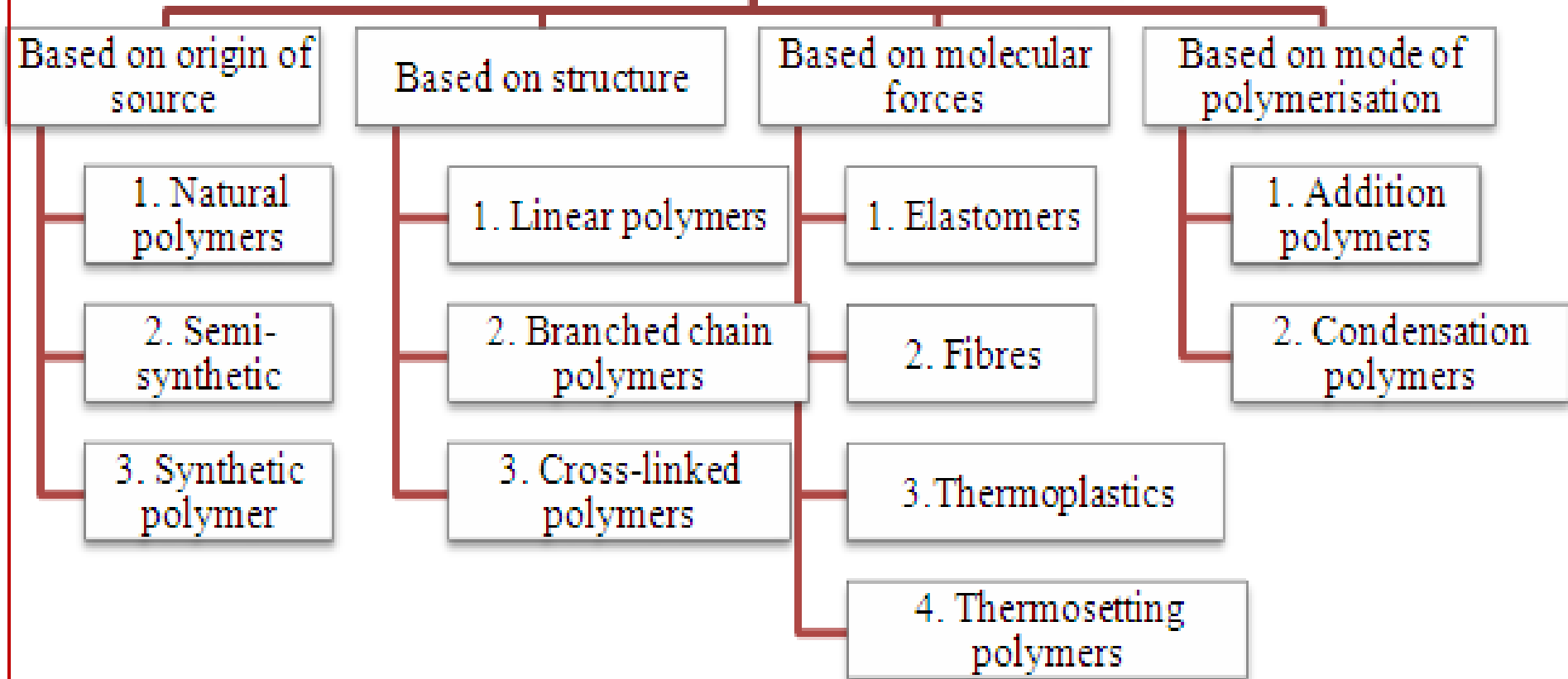

Classification of Polymers

Polymers are classified in a number of ways:

(1) On the basis of source or origin

(2) On the basis of structure

(3) On the basis of mode of synthesis

(4) On the basis of interparticle forces

(1) Classification of Polymers Based upon Origin or Source

On the basis of origin or source, the polymers are classified into three types:

- (a) Natural Polymers
- (b) Semi-synthetic Polymers
- (c) Synthetic Polymers

(a) Natural Polymers: The polymers, which are isolated from natural materials, mostly plants and animal sources, are called natural polymers. The classification of natural polymers are:

CLASSIFICATION

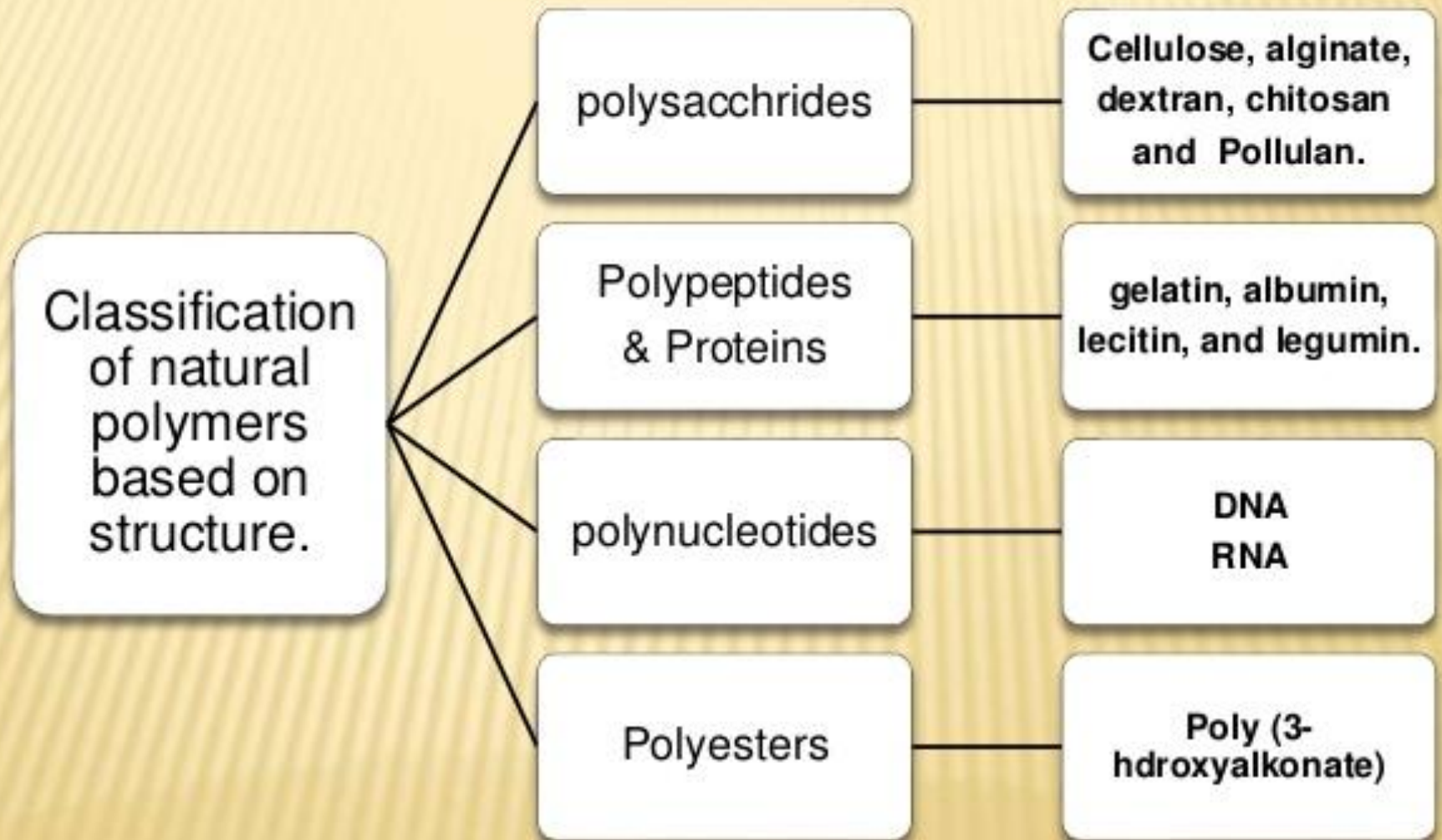

(i) Polysaccharides

- Starch and cellulose are very common examples of polysaccharides. They are the polymers of glucose. Starch is a chief food reserve of plants while cellulose is chief structural material of plants.

Structure of Starch

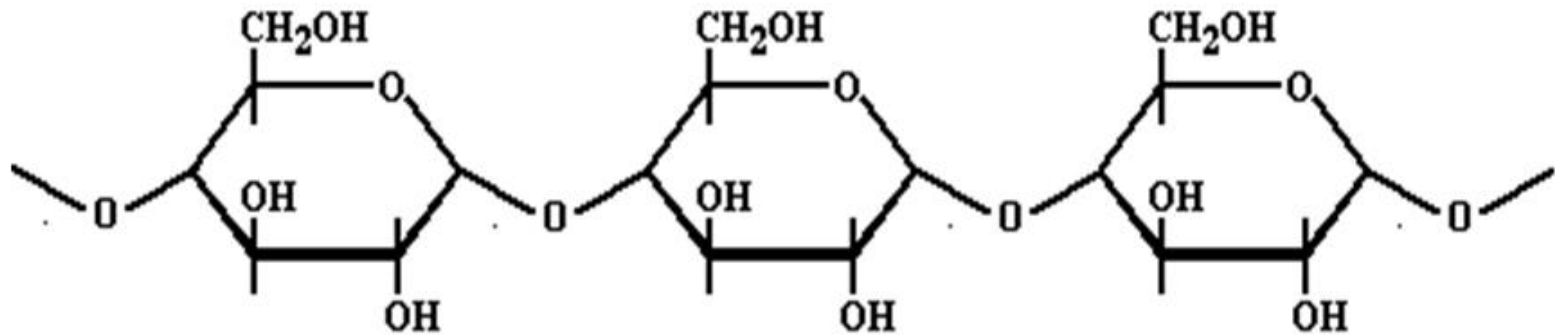

Structure of Cellulose

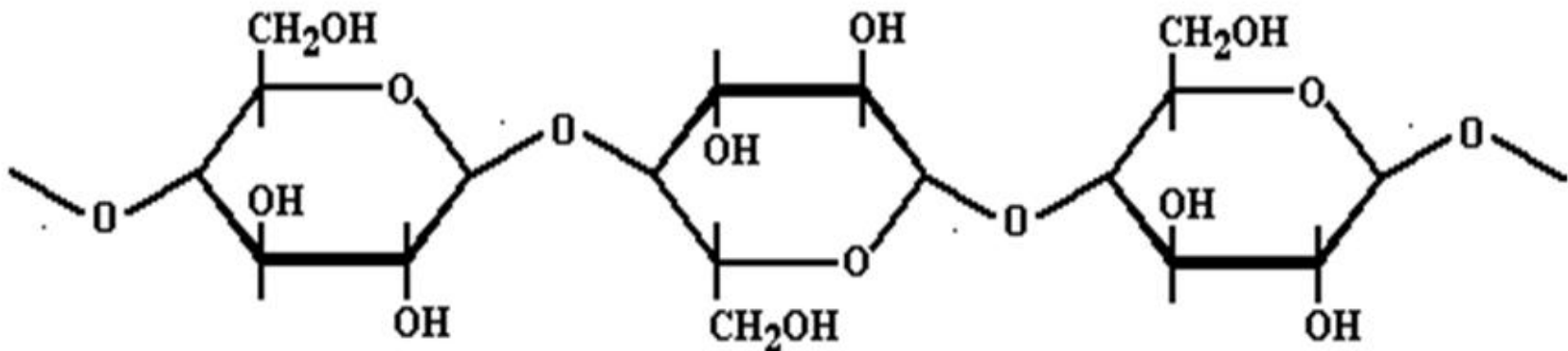

(ii) Polypeptides and Proteins

- Amino acids are the building blocks for proteins. All amino acids contain an amino or NH_2 group and a carboxyl (acid) or COOH group. There are 20 different amino acids commonly found in proteins and often 300 or more amino acids per protein molecule.
- To form polypeptides and proteins, amino acids are joined together by peptide bonds, in which the amino or NH_2 of one amino acid bonds to the carboxyl (acid) or COOH group of another amino acid .

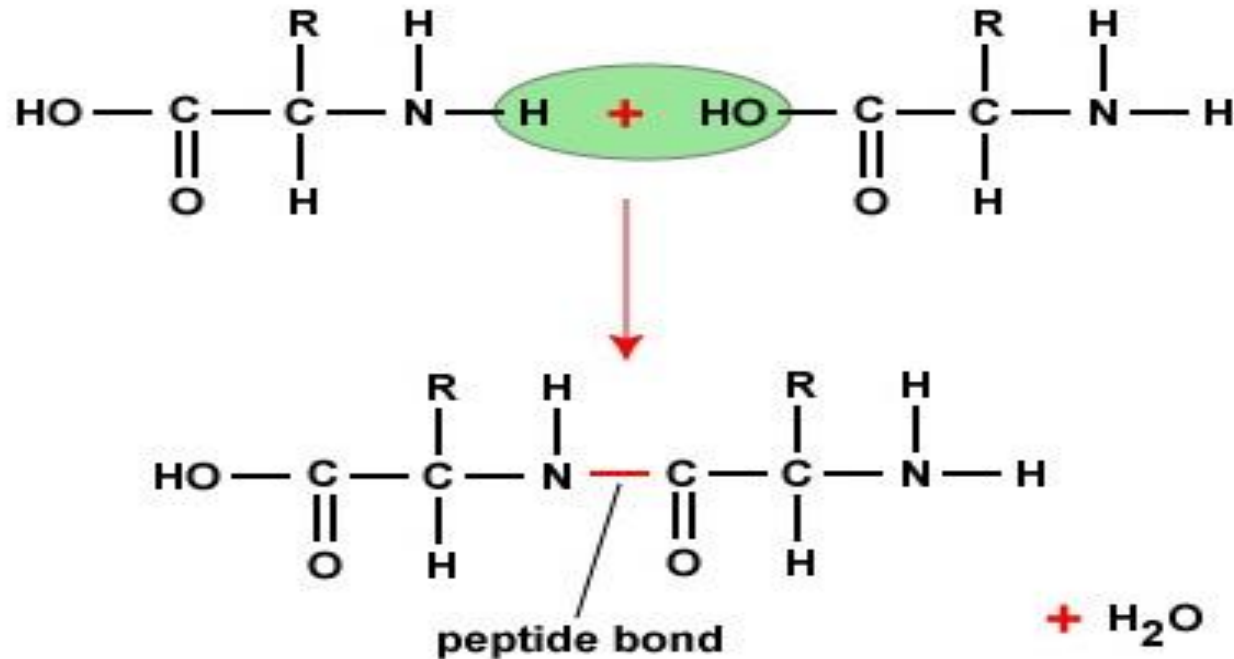

(iii) Polynucleotides

- A polynucleotide molecule is a biopolymer composed of 13 or more nucleotide monomers covalently bonded in a chain. DNA (deoxyribonucleic acid) and RNA (ribonucleic acid) are examples of polynucleotides with distinct biological function. Polynucleotides occur naturally in all living organisms.

Within a DNA or RNA Molecule

Nucleotides join together, to form polymers, called

POLYNUCLEOTIDES

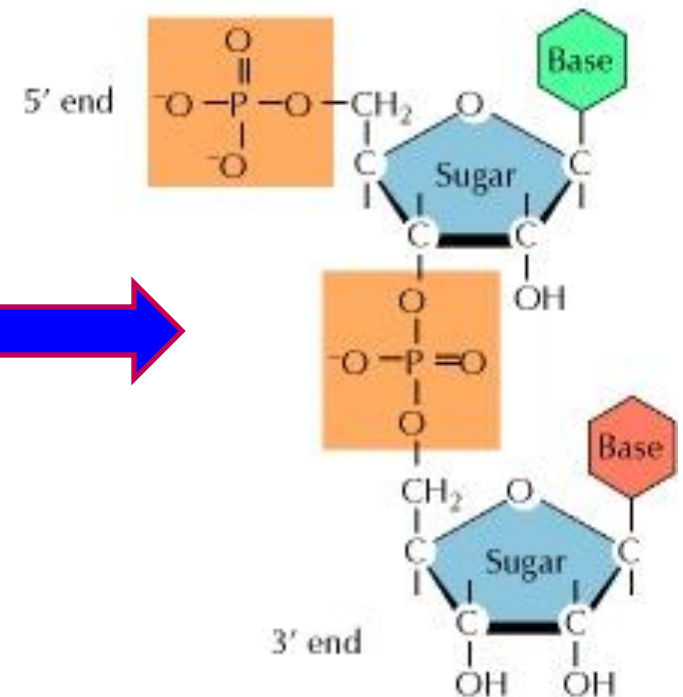
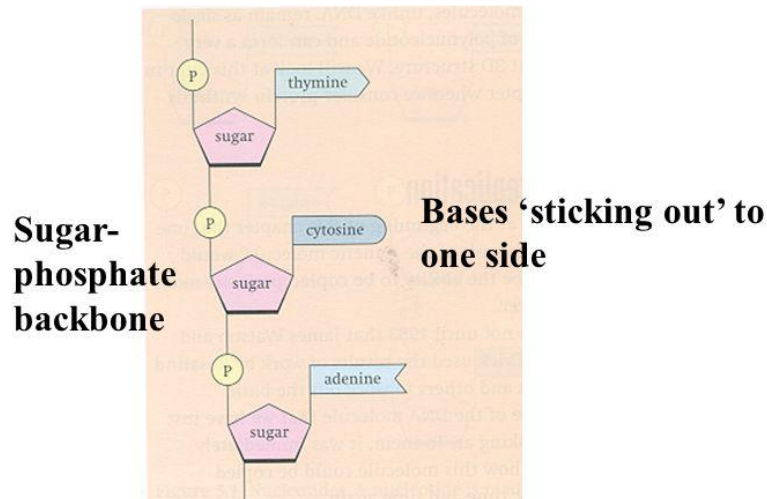

(iv) Polyesters

- Polyester is a synthetic polymer made of purified terephthalic acid (PTA) or its dimethyl ester dimethyl terephthalate (DMT) and monoethylene glycol (MEG). With 18% market share of all plastic materials produced, it ranges third after polyethylene (33.5%) and polypropylene (19.5%).

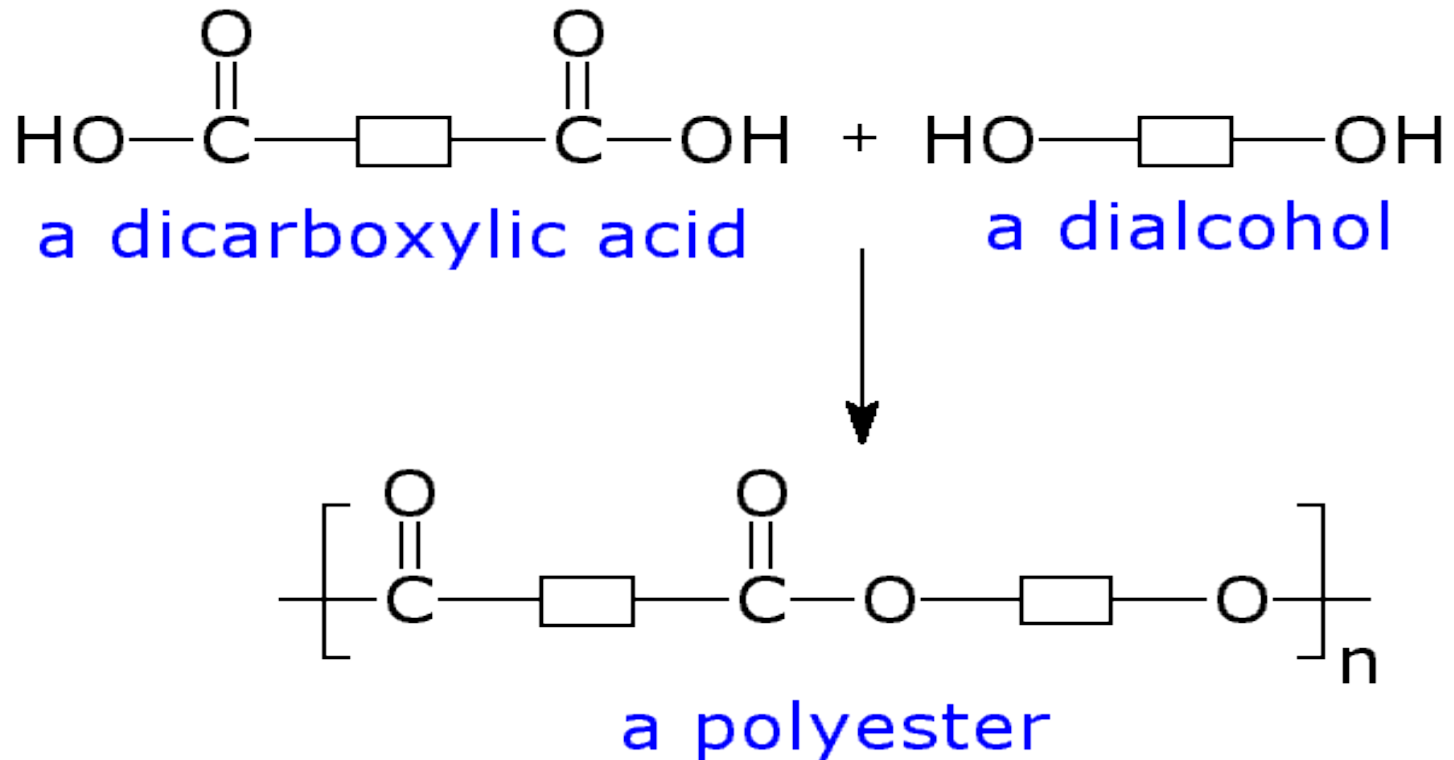

(b) Semi-synthetic Polymers

- The polymers obtained by simple chemical treatment of natural polymers to improve their physical properties like lustrous nature, tensile strength are called semisynthetic polymers

E.g. Cellulose acetate, Cellulose nitrate



Viscose/Rayon

Cellulose acetate

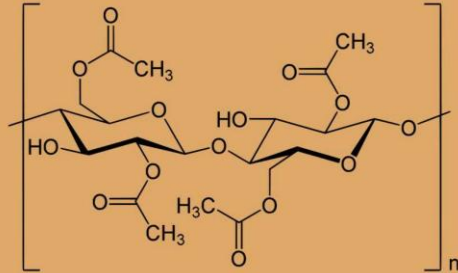

(c) Synthetic Polymers: The polymers which are prepared in the laboratory are referred to as synthetic polymers or man-made polymers. Some examples of synthetic polymers are **Polyethylene, Polystyrene, Teflon, PVC, Synthetic Rubber, Nylon, Bakelite, Orlon, Polyester, Terylene** etc.

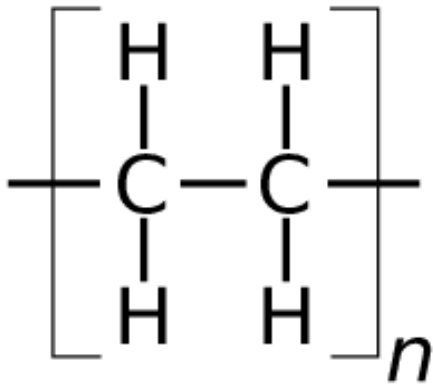

Polyethylene

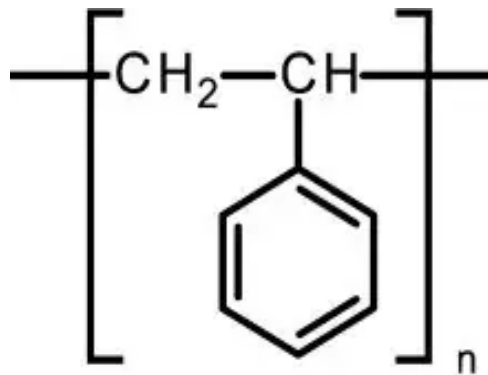

Polystyrene

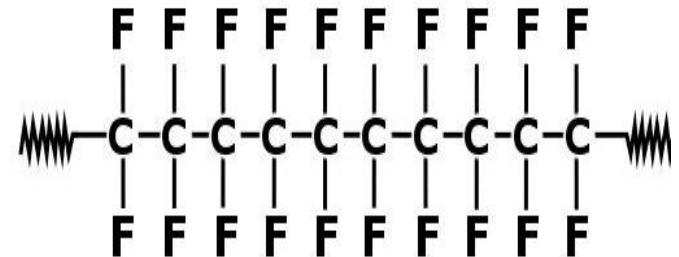

Polytetrafluoroethylene (PTFE)

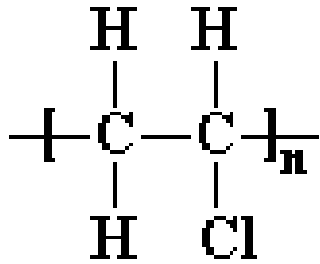

**Polyvinylchloride
(PVC)**

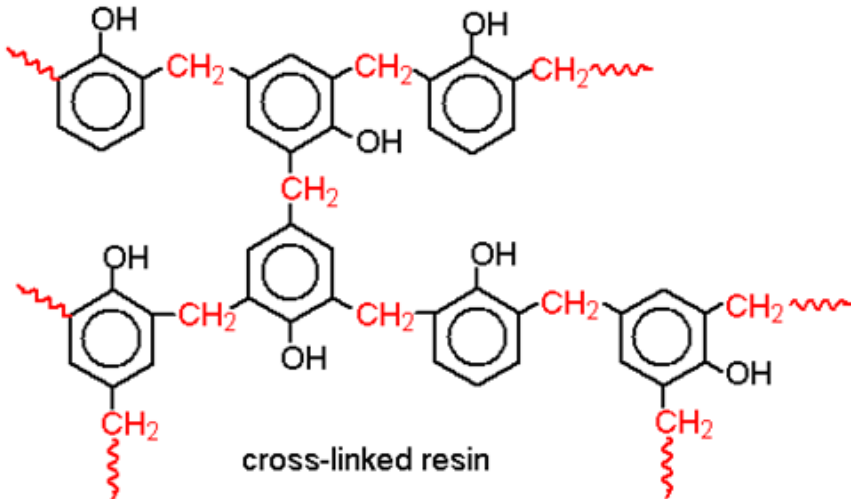
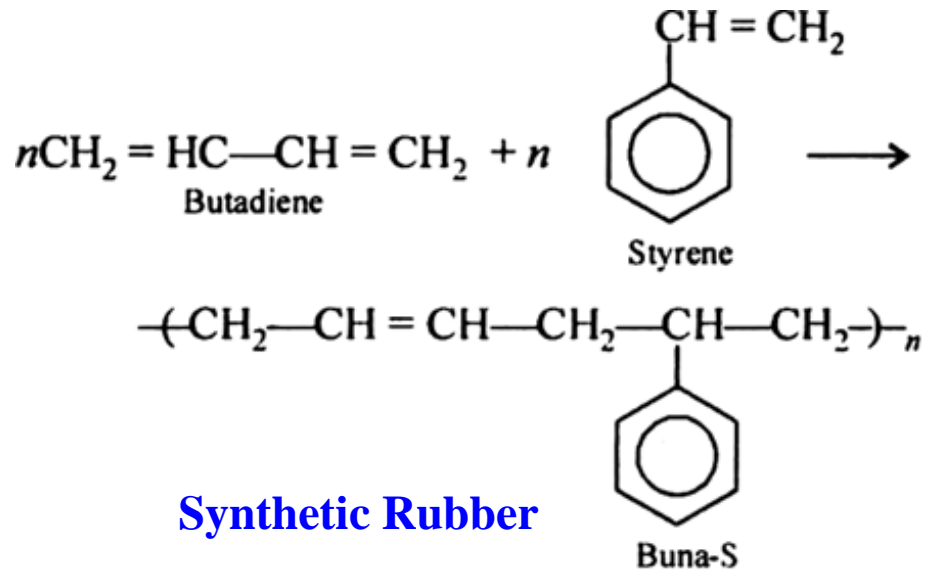

Bakelite

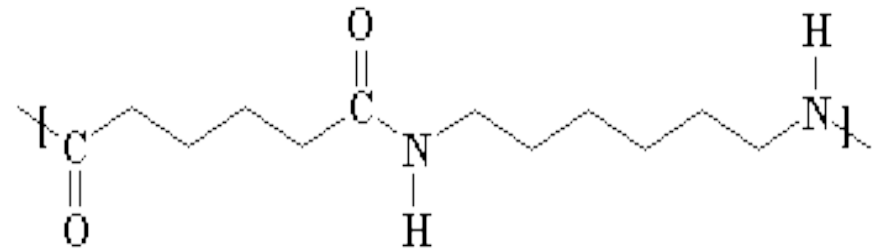

Nylon

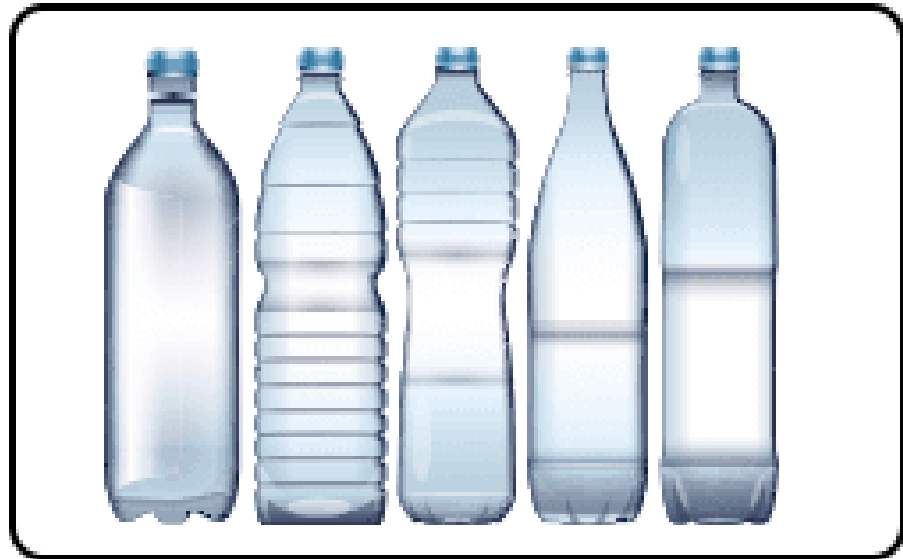

Synthetic Polymer



(2) Classification of Polymers Based on Structure

- This classification of polymers is based upon how the monomeric units are linked together. Based on their structure, the polymers are classified as :

(a) Linear Polymers

(b) Branched Chain Polymers

(c) Cross-linked Polymers or Network Polymers

(a) Linear Polymers

A polymer is a general term for any molecule that is a long string of smaller repeating parts formed by carbon-carbon bonds. The bonds can form long straight chains known as linear polymers.

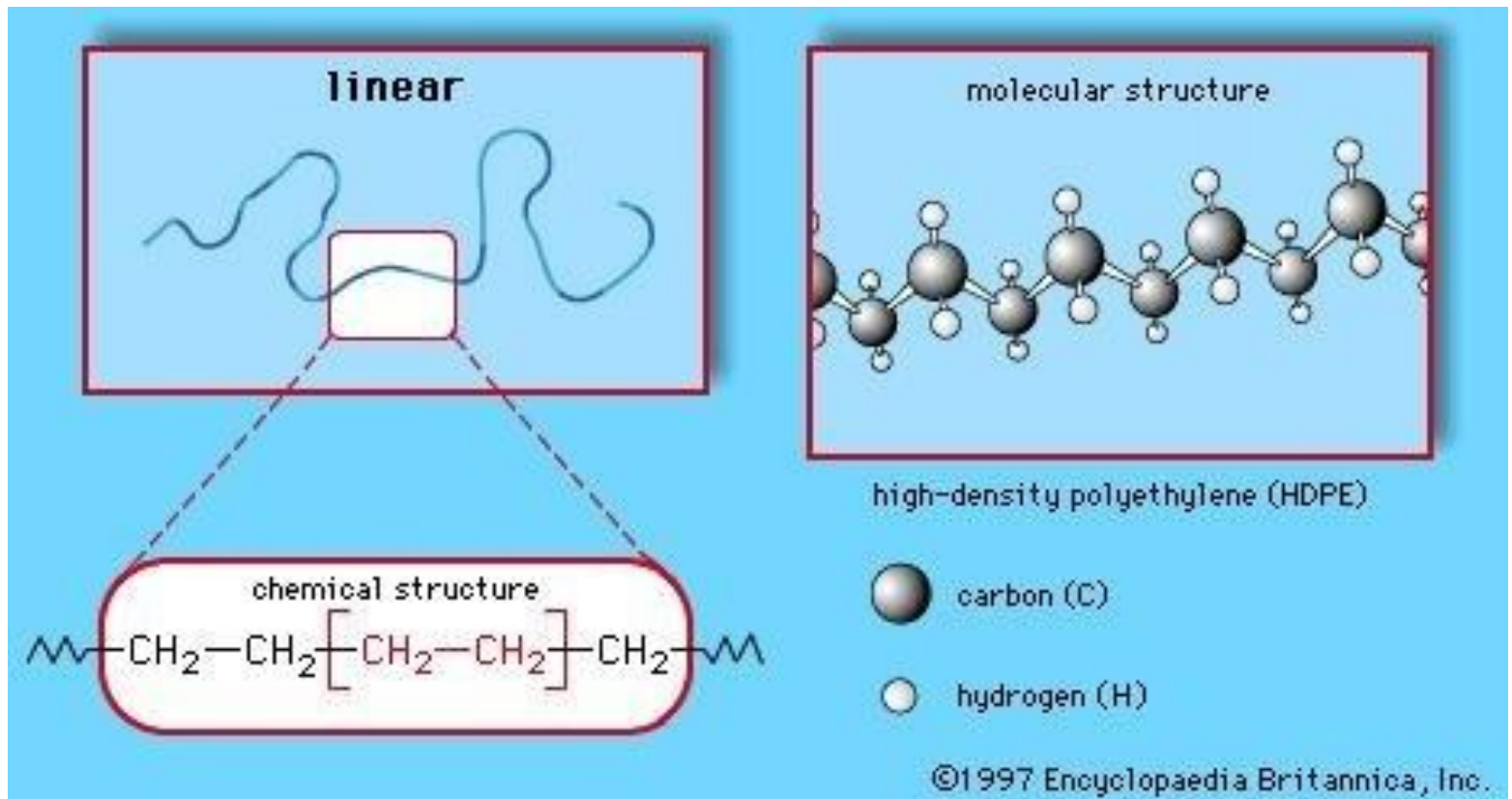

Properties of Linear Polymers

- 1) High melting point
- 2) High density
- 3) High tensile strength due to close packing of polymer chains.

Applications

Food packaging, shampoo bottles, Milk, water, and juice containers, grocery bags, toys, liquid detergent bottles, Soft drink based cups, flower pots, drain pipes, signs, stadium seats, trash cans, re-cycling bins, traffic barrier cones, golf bag liners etc.



Food packaging



Bag



Toys



Liquid detergent bottles

(b) Branched Chain Polymers

- Polymers with branches at irregular intervals along the polymer chain are called **branched polymers**
- difficult for the polymer molecules to **pack in a regular array**
- less crystalline and less dense
- amount and type of branching also **affects physical properties** such as viscosity and elasticity
- Branches often **prevent chains from getting close enough** together for intermolecular forces to work effectively.
- E.g. polyethylene
- PE is a relatively simple polymer, there are two common forms of it (high and low-density,) each with unique properties.

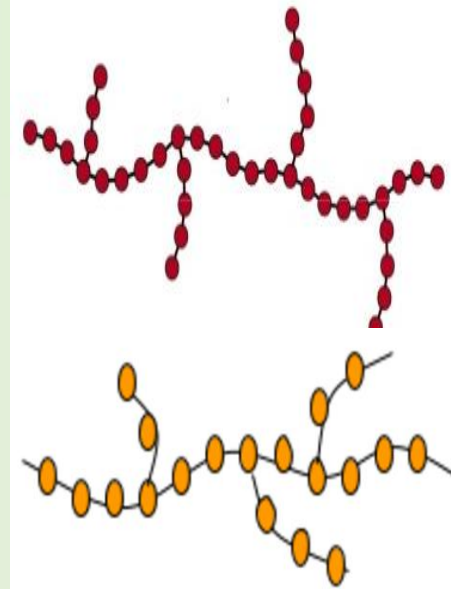
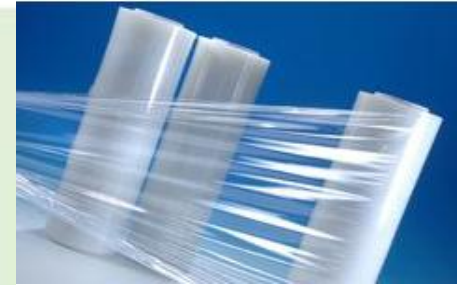

(c) Cross-linked Polymers or Network Polymers

In this type of polymers, the monomeric units are linked together to constitute a three dimensional network. The links involved are called cross links. Cross-linked polymers are hard, rigid and brittle because of their network structure. Common examples of this type of Cross-linked polymers are bakelite, formaldehyde resin, melamine, etc.

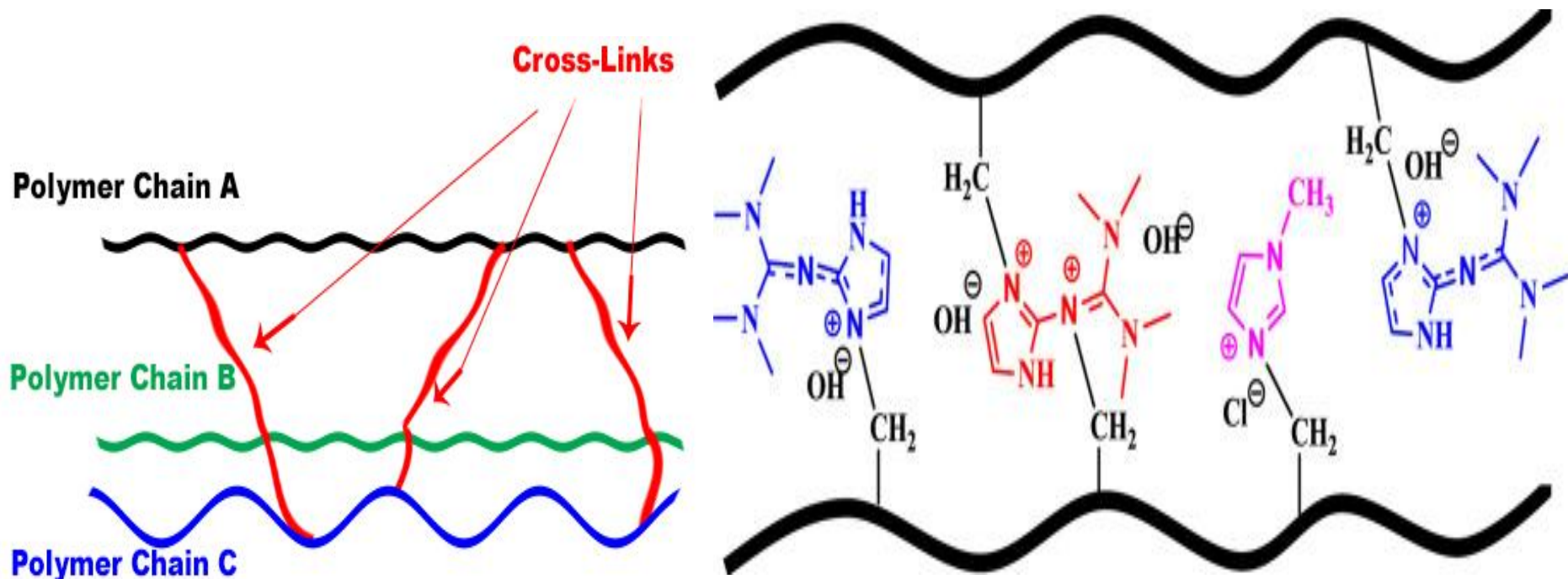

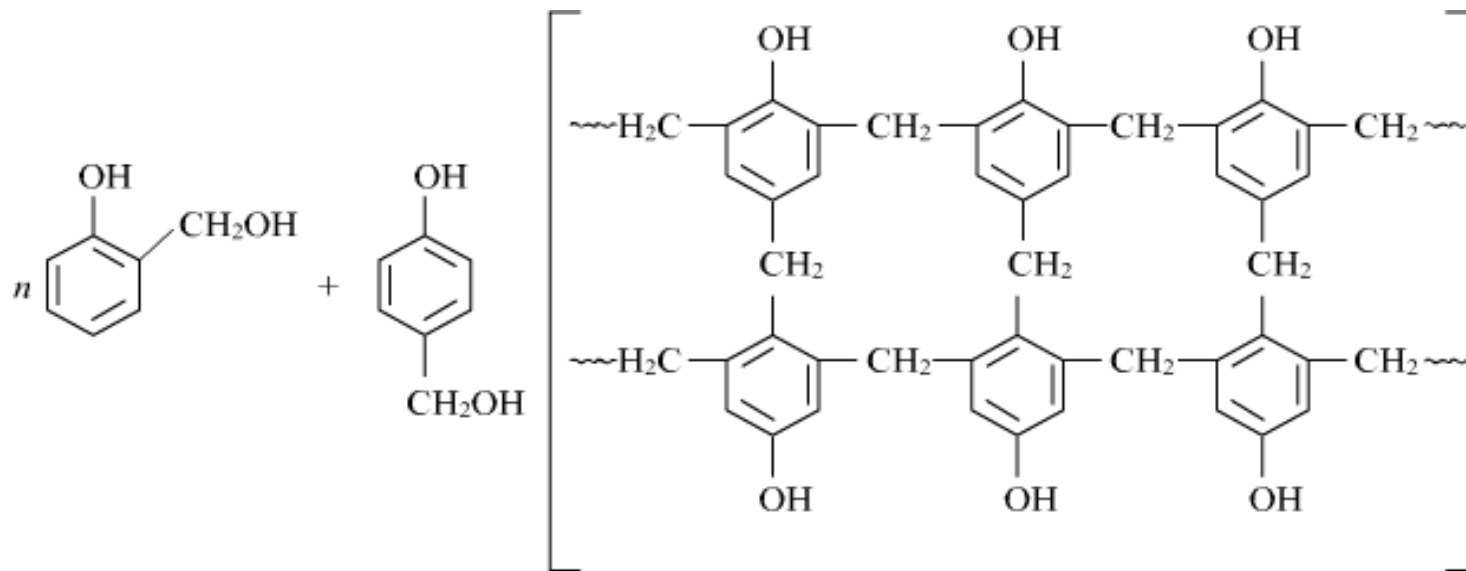

Bakelite

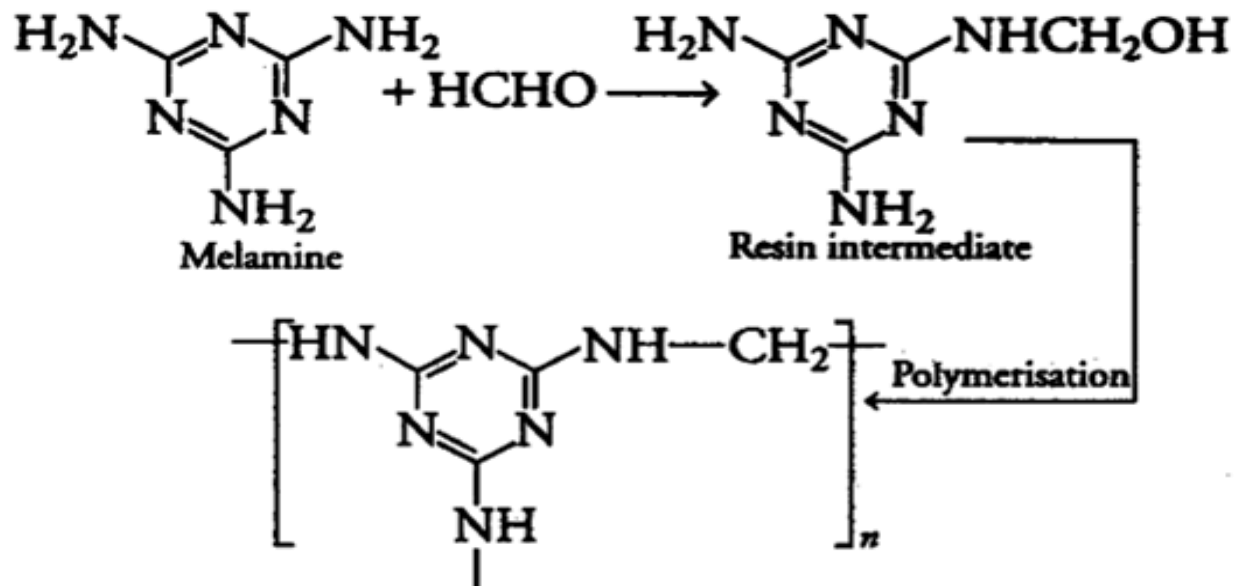

Melamine Formaldehyde Resin

(3) Classification of Polymers Based on Synthesis

- On the basis of the mode of synthesis, the polymers are classified as :

(a) Addition Polymers

(b) Condensation Polymers

(a) Addition Polymers: When the monomer units are repeatedly added to form long chains without the elimination of any by-product molecules, the product formed is called addition polymer and the process involved is called addition polymerization.

A few examples of addition polymerisation are:

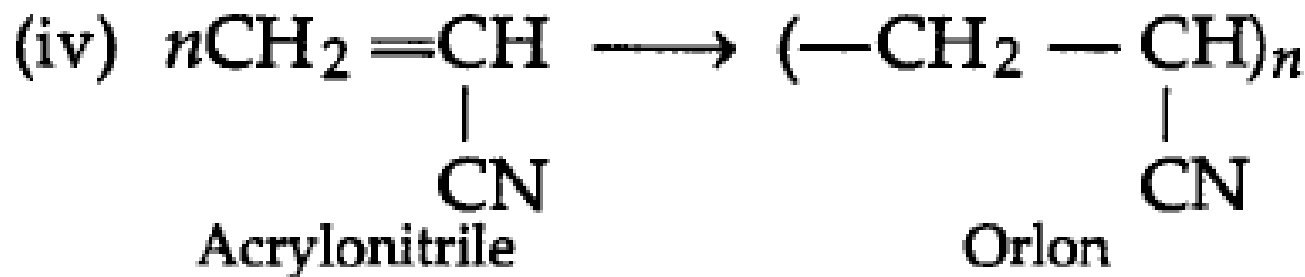
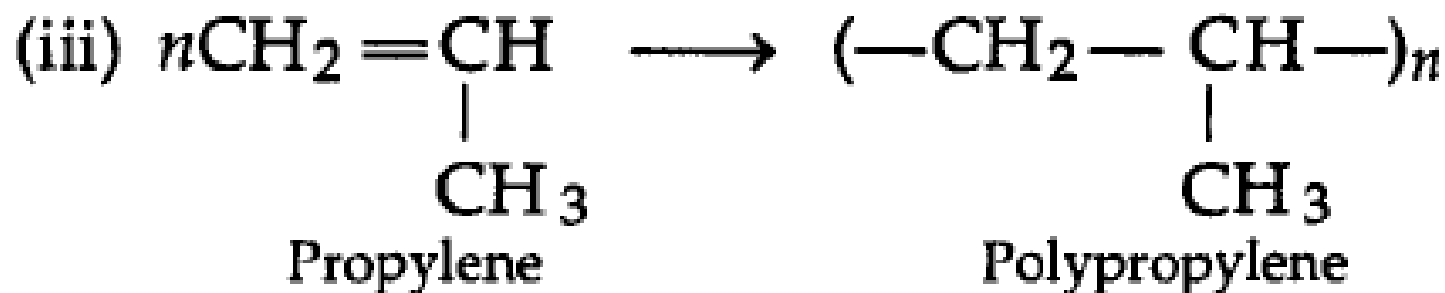
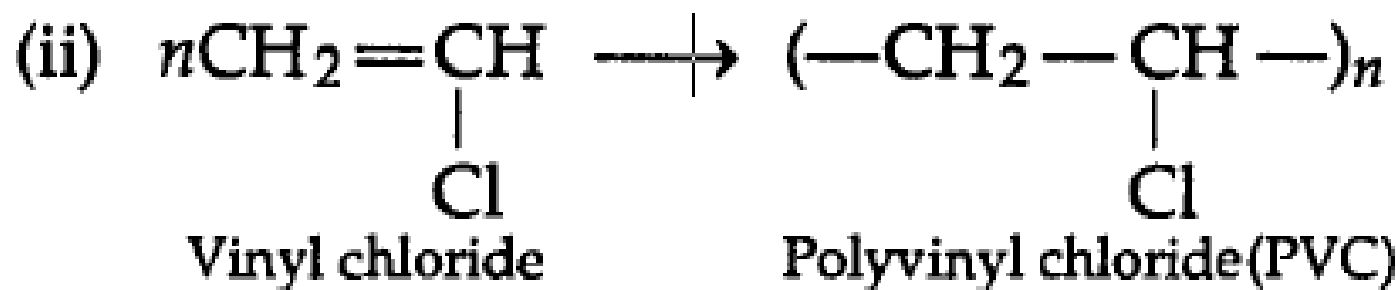
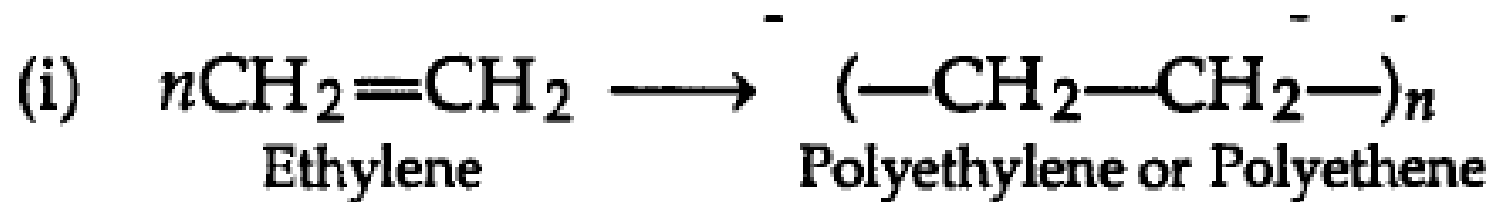

(b) Condensation Polymers: In this type of polymers, the monomers react together with the elimination of a simple molecule like H_2O , NH_3 or ROH , etc. The reaction is called condensation and the product formed is called condensation polymer.

- As the process involves the elimination of by-product molecules, the molecular mass of the polymer is not the integral multiple of the monomer units.

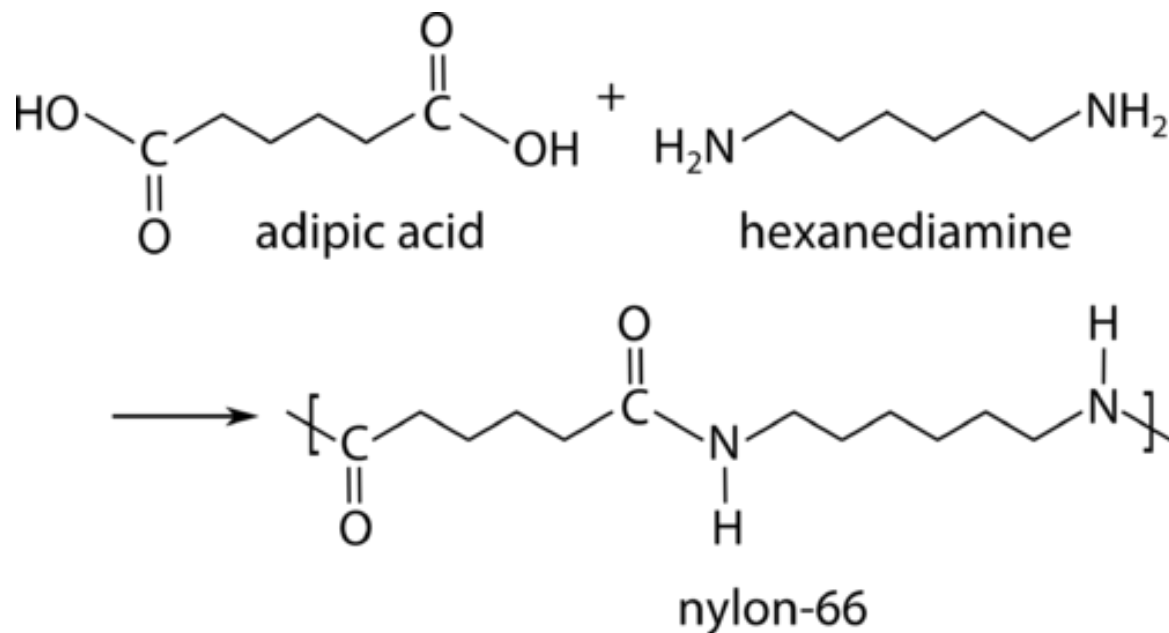

Dacron

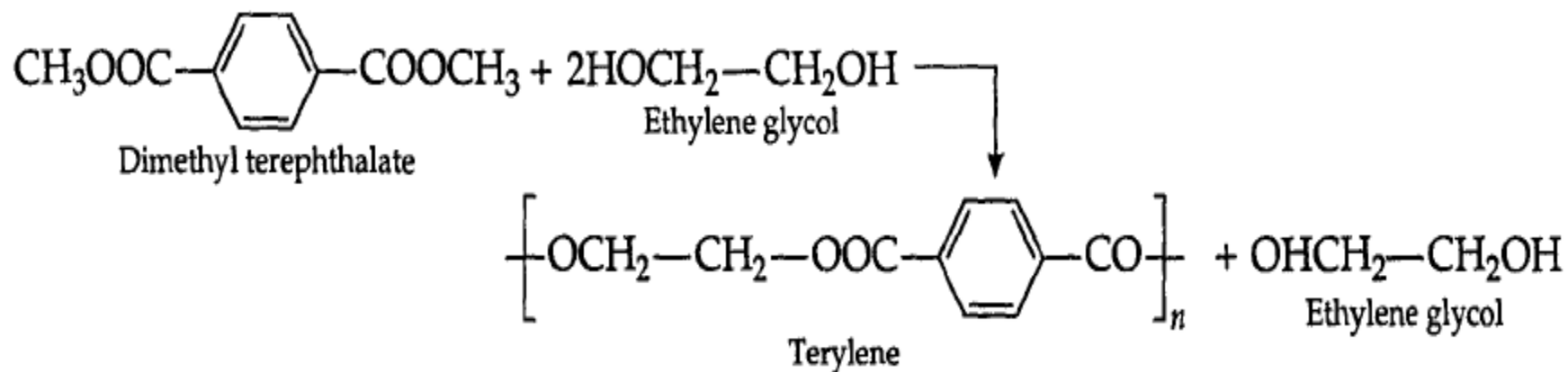

Bakelite

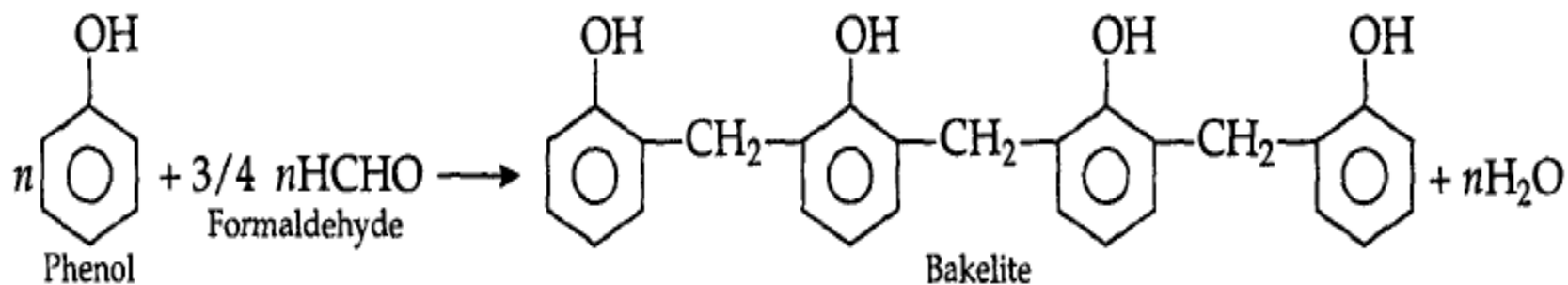

(4) Classification of Polymers Based on Inter Particle Forces:

On the basis of the magnitude of intermolecular forces, the polymers have been classified into the following four categories:

- (a) Elastomers
- (b) Fibers
- (c) Thermoplastics
- (d) Thermosetting Polymers

(a) Elastomers:

- These are the polymers in which the polymer chains are held up by weakest attractive forces. They are amorphous polymers having high degree of elasticity.
- The weak forces permit the polymer to be stretched out about ten times their normal length but they return to their original position when the stretching forces is withdrawn.
- These polymers consist of randomly coiled molecular chains having few cross links.

- When the stress is applied, these randomly cross chains straighten out and the polymer gets stretched. As soon as the stretching force is released, the polymer regain the original shape
- because weak forces do not allow the polymer to remain in the stretched form.



(b) Fibers

- These are the polymers which have quite strong interparticle forces such as Hydrogen-bonds. They have high modulus and high tensile strength.
- These are thread-like polymers and can be woven into fabrics. Silk, terylene, nylon, etc., are some common examples of such types of polymers. The H-bonds in nylon-66 are shown below:



(c) Thermoplastics: These are the polymers in which the interparticle forces of attraction are in between those of Elastomers and fibers.

- The polymers can be easily molded into desired shapes by heating and subsequent cooling to room temperature. There is no cross-linking between the polymer chains.
- Thermoplastics polymers soften on heating and becomes fluids, but on cooling they become hard. They are capable of undergoing such reversible changes on heating and cooling repeatedly.

A few examples of Thermoplastics are:

- polyethylene, polystyrene, PVC etc.

(d) Thermosetting Polymers:

- These are the polymers which become hard and infusible on heating.
- They are normally made from semi-fluid substances with low molecular masses, by heating in mould. Heating results in excessive cross-linking between the chains forming three dimensional network of bonds as a consequence of which a non-fusible and insoluble hard material is produced

Polymerization

- Polymerization is a process which allows simple low molecular weight compounds to combine and forms a complex high molecular weight compound. For this process, each molecule of the compound should have the capability to react at least with two other molecules of the same or some other compound.
- The functionality of a compound depends on the number of its reactive sites. Due to the presence of the reactive functional groups, a compound assumes its functionality. These groups are such as **-OH**, **-COOH**, **-NH₂**, **-SH**, **-NCO**, etc. The number of these functional groups per molecule of the compound defines its functionality.

(1) ADDITION (CHAIN) POLYMERISATION

- This type of polymerisation is characterised by a self-addition of the monomer molecules, rapidly through a chain reaction
- In this reaction no byproduct is formed. Since the compounds containing reactive double bonds, therefore, can proceed by a chain reaction mechanism.

Some examples are :-

(a) Olefines ($\text{CH}_2=\text{CHR}$)

Ethylene

Propylene

Isobutylene

(b) Dienes ($\text{CH}_2=\text{CR}-\text{CH}=\text{CH}_2$)

Isoprene

1, 3-Butadiene

Chloroprene

(c) Vinyl compounds ($\text{CH}_2=\text{CHX}$)

Acrylamide , Acrylic Acid, Styrene, Acrylonitrile

(A) Free-Radical Addition Polymerisation

The polymer chain is initiated by free radicals produced by the decomposition of compounds called initiators:

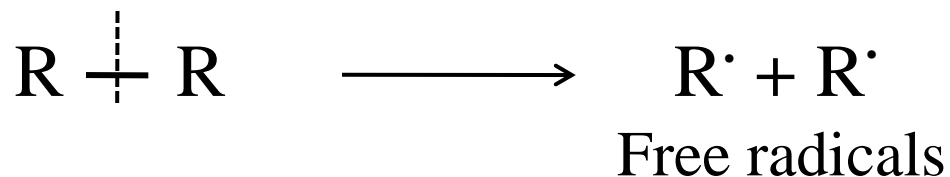

- The initiators can also be decomposed by using ultraviolet light and form the same free radicals as those formed by its thermal decomposition.
- The polymerisation reactions initiated by UV light are known as 'photo initiated polymerization' .

- Free-radicals are also formed when initiators are induced by suitable catalysts. The decomposition of hydrogen peroxide by a ferrous ion and hydro peroxide by a cobaltous ion are the examples of initiators, decomposed by reduction-oxidation (redox) reaction.



Kinetics of Polymerization

- **Stepwise polymerization:** Any two monomers present in the reaction mixture can link together at any time. The growth of the polymer is not confined to chains that are already formed.
- **Chain polymerization:** an activated monomer attacks another monomer, links to it, then that unit attacks another monomer, and so on.

Stepwise polymerization

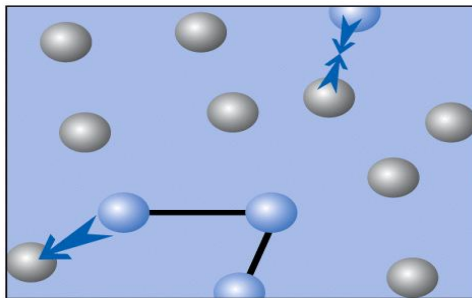

(a)

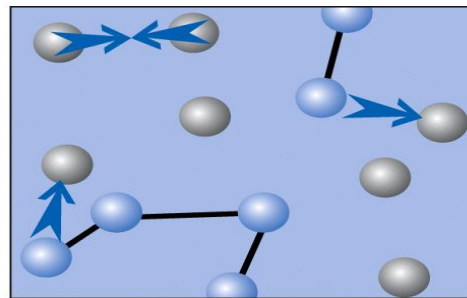

(b)

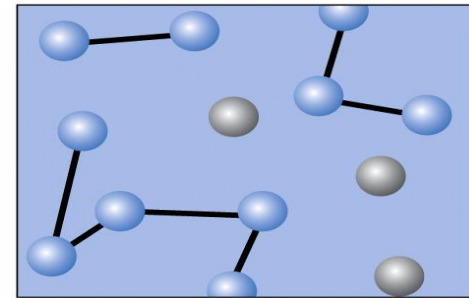

(c)

- Commonly proceeds through a condensation reaction, in which a small molecule is eliminated in each step.
- The formation of nylon-66



- $\text{HO-M-COOH} + \text{HO-M-COOH} \rightarrow \text{HO-M-COO-M-COOH}$
- Because the condensation reaction can occur between molecules containing any number of monomer units, chains of many different lengths can grow in the reaction mixture.

Stepwise polymerization

- The rate law can be expressed as

$$\frac{d[A]}{dt} = -k[A]^2$$

- Assuming that the rate constant k is independent of the chain length, then k remains constant throughout the reaction.

$$[A] = \frac{[A]_0}{1 + kt[A]_0} \quad p = \frac{[A]_0 - [A]}{[A]_0} = \frac{kt[A]_0}{1 + kt[A]_0}$$

- The degree of polymerization: The average number of monomers per polymer molecule, $\langle n \rangle$

$$\langle n \rangle = \frac{[A]_0}{[A]} = \frac{1}{1 - p}$$

Chain polymerization

- Occurs by addition of monomers to a growing polymer, often by a radical chain process.
- Rapid growth of an individual polymer chain for each activated monomer.
- The addition polymerizations of ethene, methyl methacrylate, and styrene.
- The rate of polymerization is proportional to the square root of the initiator concentration.

Three basic types of reaction step in a Chain polymerization

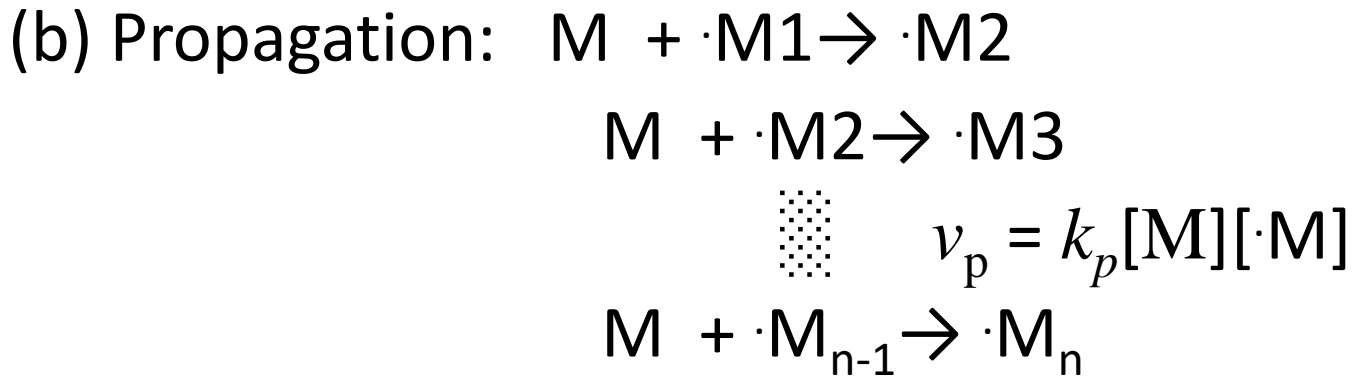
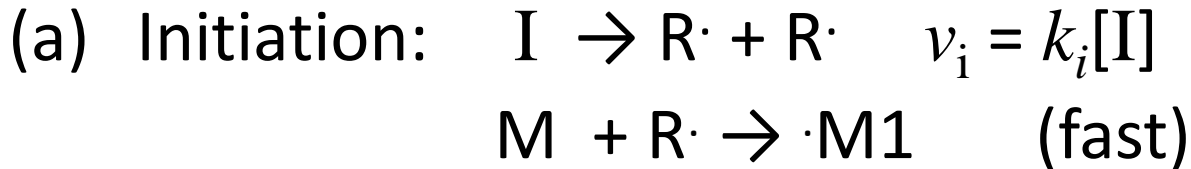

(c) Termination:

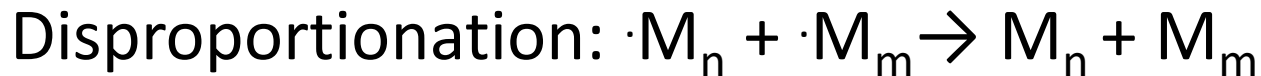

Influences of termination step on the polymerization

- Mutual termination: two growing radical chains combine. $v_t = k_t ([\cdot M])^2$
- Disproportionation: Such as the transfer of a hydrogen atom from one chain to another, which corresponds to the oxidation of the donor and the reduction of acceptor.

$$v_t = k_t ([\cdot M])^2$$

- Chain transfer: $v_t = ?$

- the net rate of change of radical concentration is calculated as

$$\left(\frac{d[\cdot M]}{dt} \right)_{\text{production}} = 2fk_i[I] - 2k_t[\cdot M]^2$$

- Using steady-state approximation (the rate of production of radicals equals the termination rate)

$$[\cdot M] = \left(\frac{fk_i}{k_t} \right)^{1/2} [I]^{1/2}$$

- The rate of polymerization

$$v_p = k_p[\cdot M][M] = k_p[M] \left(\frac{fk_i}{k_t} \right)^{1/2} [I]^{1/2}$$

The above equation states that the rate of polymerization is proportional to the square root of the concentration of the initiator.

Kinetic chain length, ν ,

$$\nu = \frac{\textit{number of monomer units consumed}}{\textit{number of activated centres produced}} = k[M][I]^{-1/2}$$

$$\textit{where } k = \frac{1}{2} k_p (fk_i k_t)^{-1/2}$$

$$\langle n \rangle = 2\nu \quad (\text{for mutual termination})$$

- Example: For a free radical addition polymerization with $k_i = 5.0 \times 10^{-5} \text{ s}^{-1}$, $f = 0.5$, $k_t = 2.0 \times 10^7 \text{ dm}^3 \text{ mol}^{-1} \text{ s}^{-1}$, and $k_p = 2640 \text{ dm}^3 \text{ mol}^{-1} \text{ s}^{-1}$, and with initial concentrations of $[M] = 2.0 \text{ M}$ and $[I] = 8 \times 10^{-3} \text{ M}$. Assume the termination is by combination.
 - (a) The steady-state concentration of free radicals.
 - (b) The average kinetic chain length.
 - (c) The production rate of polymer.

Solution: (a)
$$[\cdot M] = \left(\frac{fk_i}{k_t} \right)^{1/2} [I]^{1/2}$$

(b)
$$v = k[M][I]^{-1/2} \quad \text{where } k = \frac{1}{2} k_p (fk_i k_t)^{-1/2}$$

- (c) The production rate of polymer corresponds to the rate of polymerization is v_p :
- $$v_p = k_p [\cdot M][M]$$

Generalization of the Foregoing Concepts

- The number-average molecular weight is designated as \overline{Mn} and the weight-average molecular weight is designated as \overline{Mw} .
- To calculate the molecular weight of a polymer one can also use either the number-fraction or the weight-fraction of the molecules present in the polymer.
- With the help of ordinary mathematics, one can be easily generalised the method of working out \overline{Mn} and \overline{Mw} .

- Suppose that there are n number of molecules are present in a polymer sample and n_1 of them have M_1 molecular weight, and n_2 have M_2 molecular weight and so on till one get n_i having M_i molecular weight;

Now, the total number of molecules (n) given by :

$$n = n_1 + n_2 + n_3 \dots + n_i = \sum n_i$$

Number of molecules in fraction 1 = n_1

Number-fraction of fraction 1 = $\frac{n_1}{n} = \frac{n_1}{\sum n_i}$

Molecular weight contribution by fraction 1 = $\frac{n_1 M_1}{\sum n_i}$

Similarly, molecular weight by contribution by other fractions will be as follows :

$$\frac{n_2M_2}{\Sigma n_i}, \frac{n_3M_3}{\Sigma n_i}, \dots, \frac{n_iM_i}{\Sigma n_i}$$

Number-average molecular weight of the whole polymer will then be given by,

$$\frac{n_1M_1}{\Sigma n_i} + \frac{n_2M_2}{\Sigma n_i} + \dots + \frac{n_iM_i}{\Sigma n_i} = \frac{\Sigma n_iM_i}{\Sigma n_i} = \bar{M}_n$$

Similarly, total weight of the polymer = $W = \Sigma n_iM_i$

Weight of fraction 1 = $W_1 = n_1M_1$

Weight-fraction of fraction 1 = $\frac{n_1M_1}{W} = \frac{n_1M_1}{\Sigma n_iM_i}$

Molecular weight contribution by fraction 1 is given by

$$= \frac{n_1M_1M_1}{\Sigma n_iM_i} = \frac{n_1M_1^2}{\Sigma n_iM_i}$$

Similarly, the molecular weight contribution by the other fractions will be

$$\frac{n_2 M_2^2}{\Sigma n_i M_i}, \frac{n_3 M_3^2}{\Sigma n_i M_i}, \dots, \frac{n_i M_i^2}{\Sigma n_i M_i}$$

The weight-average molecular weight of the whole polymer will then be

$$\frac{n_1 M_1^2}{\Sigma n_i M_i} + \frac{n_2 M_2^2}{\Sigma n_i M_i} + \dots + \frac{n_i M_i^2}{\Sigma n_i M_i} = \frac{\Sigma n_i M_i^2}{\Sigma n_i M_i} = \bar{M}_w$$

For all synthetic polymers, \bar{M}_w is greater than \bar{M}_n . If they were to be equal, the polymer sample may be considered as perfectly homogeneous (*i.e.*, each molecule has the same molecular weight), but this does not happen.

NUMBER-AVERAGE CONCEPT

The number-average molecular weight of a polymer can be calculated by the following ways:

Suppose, a bag containing four different types of fruits: apples, papayas, pine apples and watermelons. To clarify and just for understanding, let each apple of the apple lot weight the same, and similarly also each of the other fruits. Suppose that the number of each fruit and its weight are as given below:

Fruits	Number (n)	Weight M (g)	Total weight of each fruit $W = nM$ (g)
Apples	6	10	60
Papayas	4	50	200
Pine apples	3	100	300
Watermelons	2	200	400
	15		960

Now, we have to find out the average weight of the fruits present in the bag. It is assumed that the individual fruit contributes to the average weight in the ratio of its numbers. Then we get the number-average weight as follows:

Total number of fruits in the bag = 15

Total number of the apples in the bag = 6

Therefore,

Number fraction of fruits (to the total number of fruits) = $6/15$

In the same manner, Number fraction of papayas = $4/15$

Number fraction of pine apples = $3/15$

Number fraction of watermelons = $2/15$

Contribution made by 6 apples towards average weight of fruits in the bag;

Number fraction of apples x weight of each apple

$$= 6/15 \times 10 = 4.0 \text{ g}$$

- Similarly, contribution made by 4 papayas to the average weight of fruits in the bag = $4/15 \times 50 = 13.30 \text{ g}$
- Similarly, contribution made by 3 pine apples to the average weight of fruits in the bag = $3/15 \times 100 = 20.0 \text{ g}$
- Similarly, contribution made by 2 watermelons to the average weight of fruits in the bag = $2 \times 200 = 26.60 \text{ g}$

By summing up the contributions made by each fruits variety, we get the number-average weight of the total fruits as the :

$$4.0 + 13.30 + 20.0 + 26.60 = 63.90 \text{ g}$$

WEIGHT-AVERAGE CONCEPT

The weight-average can be calculated by the other method which is based on the assumption that the individual fruit variety contribute to the total weight in the proportion not of its number but its weight. The weight-average can be get as :

Total weight of all the fruits present in the bag = 960 g

Weight of apples present in the bag = 60 g

Therefore, Weight fraction of apples = $60/960$

- Similarly, weight fractions of papayas, pine apples, and watermelons are $200/960$, $300/960$ and $400/960$ respectively.

Next, contribution made by apples towards average-weight of fruits in the bag =

Weight fraction of apples x Average weight of apples

$$60/960 \times 10 = 0.62 \text{ g}$$

Similarly,

Corresponding contribution by papayas = $200/960 \times 50 = 1.41 \text{ g}$

Corresponding contribution by pine apples = $300/960 \times 100 = 31.2 \text{ g}$

Corresponding contribution by watermelons = $400/960 \times 200 = 83.3 \text{ g}$

Summing up the contributions made by each fruit variety, we get the weight-average weight of the total fruits as :

$$\mathbf{0.62 + 1.41 + 31.2 + 83.3 = 116.53 \text{ g}}$$

Methods of Molecular mass determination

(1) OSMOMETRY

The osmometry technique is a very widely used method to determine the molecular weight of polymers.

It is of two types :

(i) Membrane osmometry

(ii) Vapour phase osmometry

1. Membrane Osmometry

- It is used to determine the number-average molecular weight of polymers. It is based on the principle of osmosis. In the phenomenon of osmosis a semipermeable membrane is used, which allows only one species to pass through but not the others.
- In osmometry, a semipermeable membrane is placed between a pure solvent and a solution. The solvent molecules diffuse into the solution through the membrane till the solution gets dilute. An osmotic pressure is then applied on the solution.

- The osmotic pressure is that pressure which is applied on the solution so as to totally prevent the flow of the solvent through the semipermeable membrane.
- The osmotic pressure is related to the number-average molecular weight of the polymer as :

$$\frac{\pi}{RTC} = \frac{1}{\bar{M}_n} + BC \quad \dots(1)$$

$$\left(\frac{\pi}{RTC} \right)_{C \rightarrow 0} = \frac{1}{\bar{M}_n}$$

where, π = osmotic pressure

\bar{M}_n = number-average molecular weight

C = concentration of the solution

R = universal gas constant

B = A constant called second virial coefficient

If a plot is made between $\frac{\pi}{RTC}$ and C , a straight line is obtained, the ordinate intercept of which will give $\frac{1}{\bar{M}_n}$. It is observed that since the solvent and the polymer types are the same, the slopes for the plots of different molecular weight fractions will almost be the same.

Experimental Technique: There are different types of osmometers, which are in use, *e.g.*,

(a) Fuoss-Mead block osmometer

(b) Pinner-Stabin glass osmometer

(c) Reiff osmometer

(d) Stabin-Shell automatic osmometer etc.

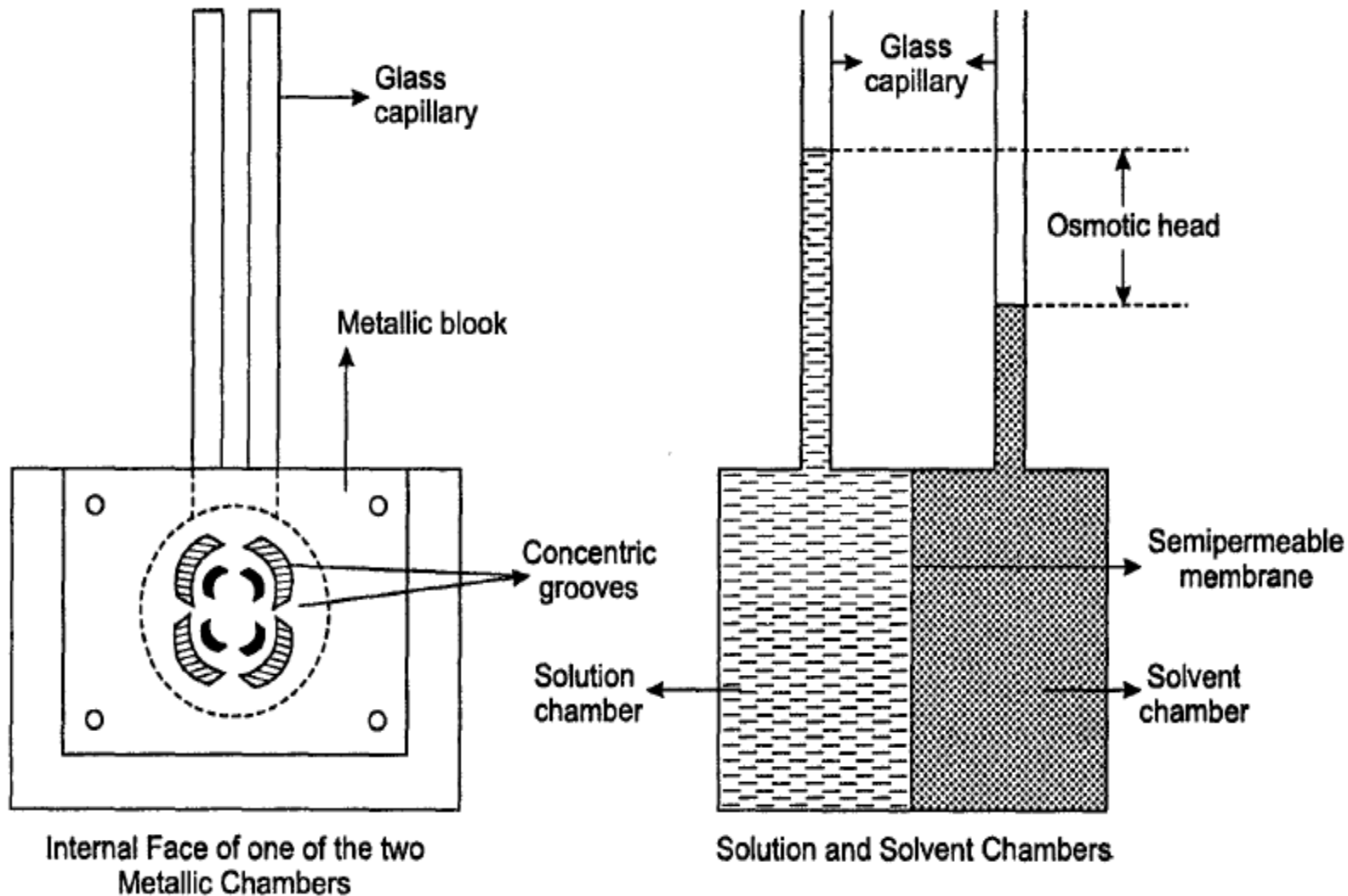

Osmometer

- The osmometer consists of two metallic chambers. These are made of stainless steel. The face of the chamber possesses a series of the concentric grooves, which are interconnected by vertical horizontal channels. In between of these grooves of the two metallic chambers, a semipermeable membrane is placed.
- The two internal grooved faces of the metallic chambers are interconnected on bolting the apparatus. These chambers are separated by only a semipermeable membrane. In between the grooves of the two chambers, the solvent and solution are placed.

- The glass capillaries are inserted through a bore-drill into the metallic chambers of the solvent and solution compartments. Both the two metallic chambers are filled with solvent one of the chamber is then emptied of the solvent and filled with the solution of known concentration.
- The osmometer is maintained at constant temperature. Due to the osmotic pressure, the solvent passes to the solution compartment through the membrane. It causes rise in liquid level in glass capillary tube.

- The process is continue until the hydrostatic pressure developed in the capillary tube due to the increased level of the solution.
- Once the osmotic equilibrium is achieved, the solvent stops entering the solution side. When this state is achieved, the height difference between the solution and the solvent levels in the two capillaries is measured with the help of a cathetometer. For that particular concentration, the height provides the 'osmotic head' of the solution.
- This procedure is repeated with solution of different concentrations and the 'osmotic heads' are measured.

If, the concentration of the solution = $C \text{ g/dl}$; the osmotic head = $h \text{ cm}$, the density of the solution = $d \text{ g/ml}$, the temperature = $T^\circ\text{K}$, the reduced osmotic head = $h/c \text{ cm. dl/g}$, the limiting osmotic head $(h/c)_{c \rightarrow 0} \text{ cm. dl/g}$ (this denoted by L for simplicity).

Then, 1 atmosphere = 1033 g wt/cm^2

Therefore π in atmosphere = $\frac{\text{Osmotic head} \times d}{1033}$

$$(\pi / C)_{C \rightarrow 0} = \frac{L \cdot d}{1033} \text{ atmosphere}$$

But,

$$(\pi / C)_{C \rightarrow 0} = \frac{RT}{\bar{M}_n} = \frac{L \cdot d}{1033}$$

Hence,

$$\bar{M}_n = \frac{1033 \cdot RT}{L \cdot d} = \frac{1033 \times 0.8205T}{L \cdot d}$$

The osmometry possesses following drawbacks :

- (a) The above method is simple but takes several hours to few days in diffusion of solvent through the semipermeable membrane. It is a very slow process and the time taken to attain equilibrium is extremely high.

- (b) The non-availability of the true semipermeable membranes, made this technique obsolete these days.

(c) Commercially available membranes such as 'gel-cellophane' membrane, 'bacterial-cellulose' membrane, and 'denitrated-collodion' membranes are permeable to very low molecular weight polymers and, hence, the average-molecular weight measured will always be higher than actual weight.

(d) Membrane osmometry is useful in the molecular weight range of 30,000 to 1,000,00.

2. Vapour Phase Osmometry

- The vapour phase osmometry is based on the fact that at a given temperature the vapour pressure of a solution is less than a pure solvent.
- For an experiment, place a drop each of a pure solvent and the solution in an atmosphere saturated with the solvent vapour. Since vapour pressure of a pure solvent is more than a solution hence, condensation of the solvent takes place from the saturated vapour phase on to the solution droplet.

- The solution droplet starts getting diluted and also heated up by the latent heat of condensation of the solvent condensing on it. Meanwhile, the temperature rises, and increases the concentration of the solvent, the vapour pressure of the solution droplet also increases steadily.
- The process of condensation and rise in the temperature continues till the vapour pressure of the solution droplet at the new elevated temperature gets equal to the pure solvent at the original temperature.

The total rise in temperature (ΔT) will be proportional to the mole fraction of the solute (n) in the solution as per the following equation :

$$\Delta T' = \frac{RT^2 n}{\Delta H_v}$$

where ΔH = Heat of vaporisation of the solvent

In an actual vapour phase osmometer, the solution and the solvent droplet are placed directly on two thermistors arranged in an wheatstone circuit. In this thermistors, the elevation in temperature can be measured in terms of bridge imbalance output voltage (ΔV). The relationship between voltage and molecular weight is as follows :

$$\frac{\Delta V}{C} = \frac{K}{\bar{M}_n} + KBC$$

where, K = calibration constant

\bar{M}_n = Average-number molecular weight

ΔV = Bridge imbalance output voltage

C = Concentration

Vapour phase osmometer is good to measure the molecular weights upto 30,000 reliably.

Instrumentation and Operation :

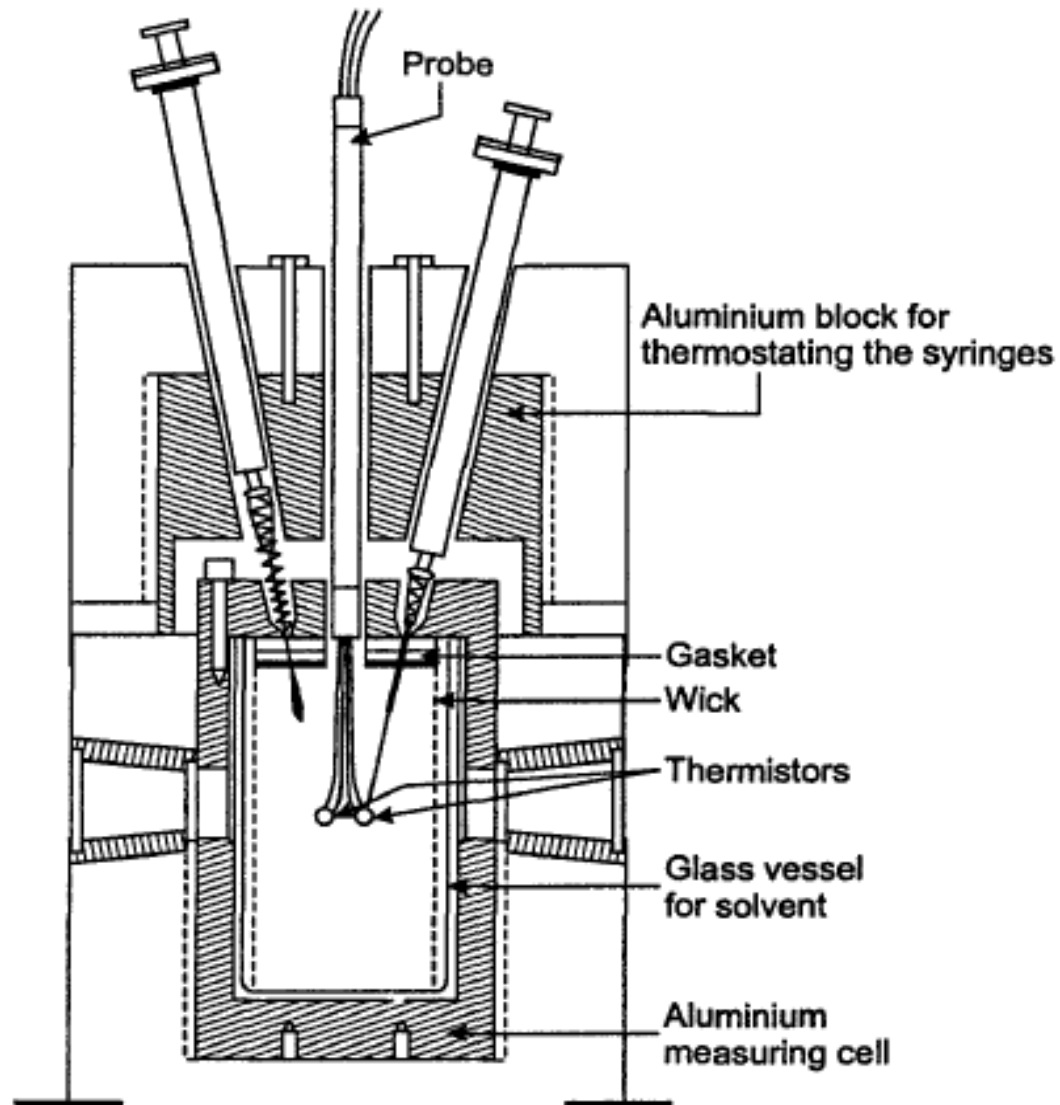

Schematic diagram of a vapour pressure osmometer

- In vapour phase osmometer a vessel is available which contains solvent. This vessel is made up of glass. It is placed in an anodised aluminium block. It is sealed by a stainless steel lid through teflon gasket.
- This vessel provides the space for the atmosphere of solvent vapour. In this vessel thermistors are placed.
- The stainless steel lid is covered by another metal block through which several syringes for placing the solution and solvent drops on the thermistors are inserted. This apparatus is maintained at a constant temperature by a thermostat.

- At the time of operation, the solvent is added to the solvent-vessel through a syringe and solvent drops are also placed on each thermistor. Since, there will not be any condensation on the thermistors, there is no temperature difference, and now the instrument reading should be zero.
- The next step is to calibrate the instrument with a standard sample of a known molecular weight. Solutions of a standard sample of four or five known concentrations are prepared.

- One of the thermistors should be used with the solution of one concentration and a drop of the same solution is placed on the thermistor, while the other thermistor still consist of a drop of the pure solvent.
- The solvent starts condensing on the solution droplet and the rise in temperature is directly measured as the bridge imbalance output voltage, ΔV , when a output attains steady state.
- This process is repeated with solutions of different concentrations, and ΔV values for each concentration is noted.

A plot between $\Delta V/C$ and C is made and extrapolated to zero concentration. The ordinate intercept will then be $(\Delta V/C)_{C \rightarrow 0}$. The calibration constant K can be calculated as :

$$K = M \cdot (\Delta V/C)_{C \rightarrow 0}$$

where M = Molecular weight of the known standard sample.

For calculating the molecular weight of an unknown sample, the solutions of the same are made in different concentrations in the same solvent used for the standard sample and

the entire process is repeated to get the ordinate intercept $(\Delta V/C)_{C \rightarrow 0}$. The molecular weight of the unknown sample will then be determined by following equation :

$$\bar{M}_n = \frac{K}{(\Delta V/C)_{C \rightarrow 0}}$$

Viscometry

Viscometer is used to determine the viscosity-average molecular weight (\bar{M}_v) of polymers. The polymer solution consists of high viscosity than a pure solvent. The relationship between the viscosity of a polymer solution and the molecular weight is as follows :

$$[\eta] = K\bar{M}^a$$

where, $[\eta]$ = intrinsic viscosity

\bar{M} = molecular weight

K and a = constants for a polymer, solvent or temperature system.

For a polymer, the K and a values have to be measured. For such measurements, the polymer sample has to be fractionated into several fractions, and for each fraction, the molecular weight is determined by osmometer or by light-scattering technique. Intrinsic viscosity is also determined for this purpose. By plotting a graph between $[\eta]$ and \bar{M} a straight line is obtained. The ordinate intercept and slope of this line will give the value of K and a , respectively.

For the determination of intrinsic viscosity the polymer solution, has to be passed through the capillary tube of viscometer.

Assume that the time required for the solution of volume V to pass through the capillary tube of radius r and length l is related to its absolute viscosity η by the Poiseuille equation as :

$$\eta = \frac{3.14 Pr^4 t}{8Vl} \quad \dots(1)$$

where, P = Pressure head where the liquid flow occurs.

$$t = \frac{8Vl\eta}{3.14 Pr^4} \quad \dots(2)$$

If η and η_0 are the absolute viscosities of a solution and the pure solvent, respectively, and t and t_0 are their corresponding flow times, the following relationships can be obtained :

$$t = \left(\frac{8Vl}{3.14 Pr^4} \right) \eta \quad \dots(3)$$

$$t_0 = \left(\frac{8Vl}{3.14 Pr^4} \right) \eta_0 \quad \dots(4)$$

For the same capillary tube, the quantities within parenthesis have the same value. Hence, dividing equation (3) by (4) :

$$\frac{t}{t_0} = \frac{\eta}{\eta_0} \quad \dots(5)$$

$\frac{\eta}{\eta_0}$ is known as the relative viscosity. Other terms related to viscosity measurements

are as follows :

$$\text{Relative viscosity} = \eta_r = \frac{\eta}{\eta_0} = \frac{t}{t_0}$$

$$\text{Specific viscosity} = \frac{(\eta - \eta_0)}{\eta_0} = \frac{(t - t_0)}{t_0} = \eta_r - 1 = \eta_{sp}$$

$$\text{Reduced viscosity} = \eta_{sp} / c = \eta_{red}, dl/g$$

$$\text{Inherent viscosity} = \ln \eta_r / c = \eta_{inh}, dl/g$$

$$\text{Intrinsic viscosity} = (\eta_{sp} / c)_{c \rightarrow 0} = (\ln \eta_r / c)_{c \rightarrow 0} = [\eta], dl/g$$

Measurement of Molecular Weight by Viscosity: Determination of molecular weight of polymers by viscosity measurement method is the most convenient and least complex method. The viscosity of the polymer solution is measured by viscometer.

For the determination of viscosity two viscometers are generally used :

(a) Ostwald viscometer

(b) Ubbelohde suspended level viscometer

- The viscometers are simple glass capillary instruments. In Ostwald viscometer all measurements should be taken using a constant volume of the solution; while in Ubbelohde suspended level viscometer, a single solution of known concentration is required and it is unaffected by the volume of the solution taken.

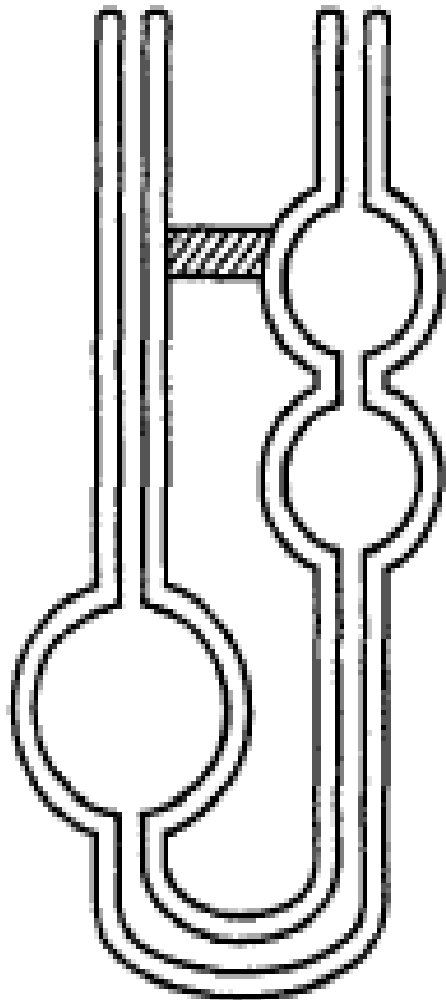

(a) Ostwald viscometer

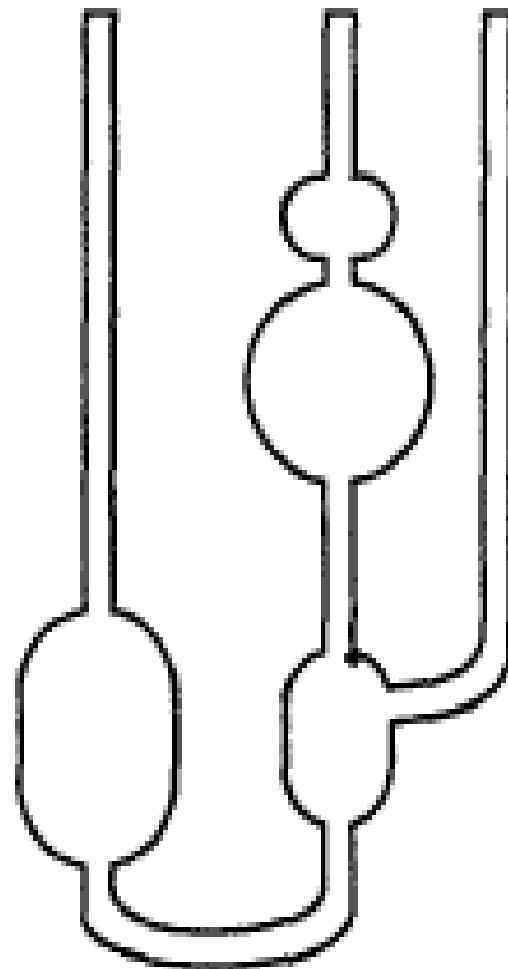

(b) Ubbelohde suspended level viscometer

Experimental Technique:

- A known volume of the solution is taken in the viscometer and the time of flow is measured.
- In Ubbelohde suspended level viscometer, known volumes of pure solvent is taken and mixed inside the viscometer itself. Thus subsequent concentrations can be achieved. This provides sufficient data of flow times at different concentrations.
- In Ostwald viscometer one has to empty, clean and refill the viscometer at each time with fresh solution before measuring the flow time.

Precautions:

1. Viscosity is a temperature dependant property, therefore, all the measurements must be taken at constant temperature.
2. Viscometer should be hold in vertical and straight direction in all the time, otherwise the pressure head will change in each measurements.
3. All solutions should be free from impurities, otherwise the capillary tube may choked and the flow of the solution may be obstructed.
4. The flow time of a solution or solvent must be sufficiently long. The difference in flow time between two successive concentrations should be atleast of 3 to 5 seconds.

LIGHT SCATTERING METHOD

- The light scattering phenomenon is used to determine the weight-average molecular weight \overline{M}_w , of polymers. It is possible because solute molecules in a solution can scatter a light beam. The scattering of the light occurs due to changes in density or refractive index within the system arising from compositional vibrations.
- The light scattering technique is a convenient method for measuring the molecular weight of polymers in the range of 10,000 to 10,000,000. This technique requires a light-scattering photometer to determine R_θ or τ experimentally. To determine n or dn/dc , this method needs a differential refractometer.

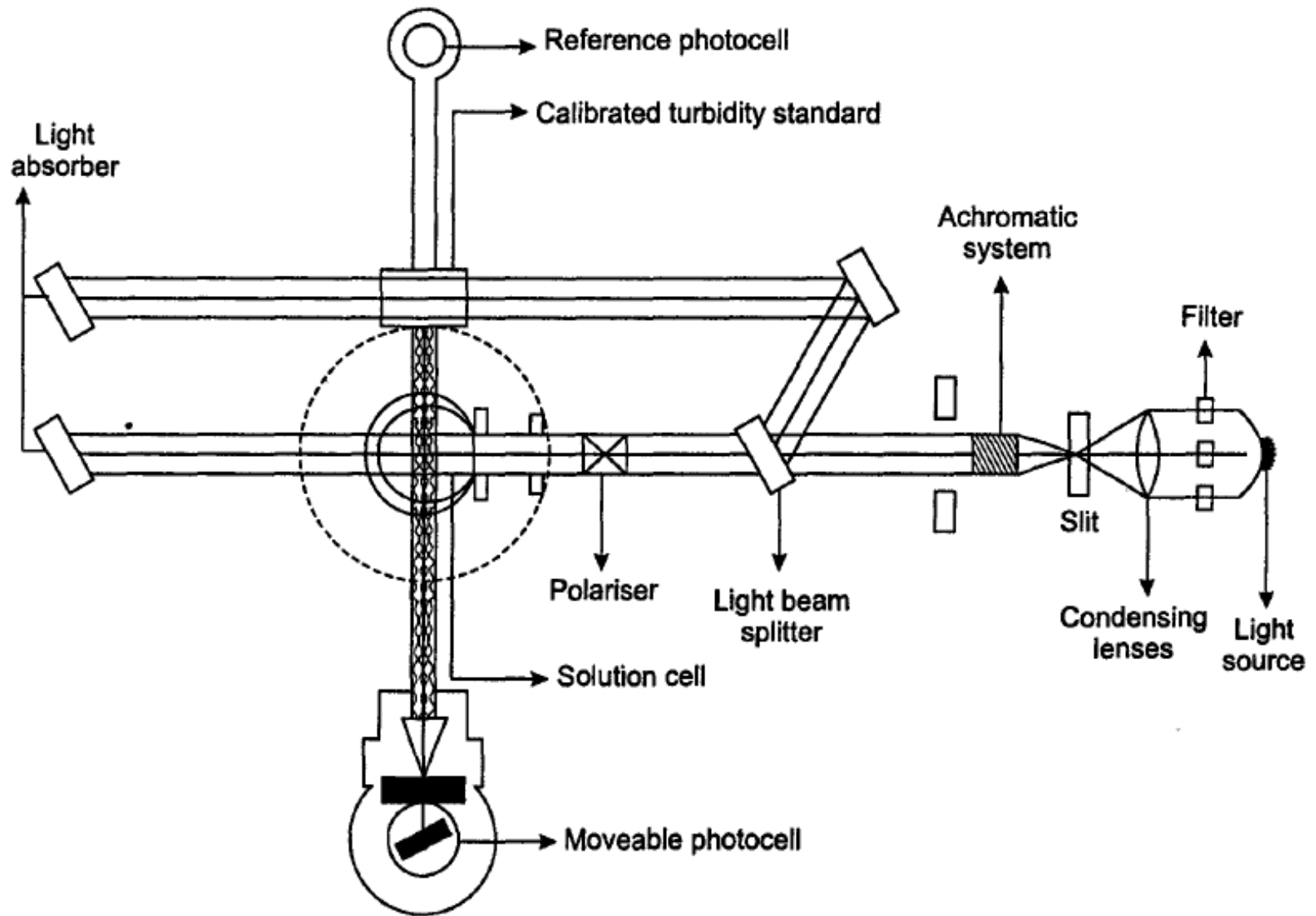

Experimental set-up for light-scattering measurements

- In an experiment for light-scattering measurements, a mercury lamp is used as a light source. After leaving the source, the light then passes through condensing lens via a monochromatic filter. It then goes through a slit and enters into an achromatic system.
- It strikes against a beam splitter, and after passing through an polariser, falls on the polymer sample solution, kept in the solution cell. After leaving the cell, the incident beam is absorbed by a light-absorber, the scattered light both from the cell and calibrated turbidity standard reaches the moveable and the reference photocell respectively.

- The turbidity can be measured from the scattered intensity. The standard solution generally used are organic liquids, colloidal suspensions or well-calibrated polymeric substances.
- The scattering values of these substances are obtained under the same conditions which are identical to the sample.
- For determining $\overline{M_w}$, apart from the scattering values, one has to measure the concentrations of polymer solution, the refractive index of the solvent and also the refractive index difference between the polymer solutions at different concentrations and the solvent.

- In light-scattering experiment, the sample solution should be prepared completely dust free.
- In light-scattering phenomenon, the amplitude of scattering is found to be proportional to the mass M ; of the particle which scatters the beam of light.

- In 1944, Debye expressed a relation between the molecular weight of the solute particle to the intensity of scattered light. This is a Debye equation and good for particles which are smaller than the wavelength of light used for the scattering experiment :

$$\frac{KC}{R_{90}} = \frac{HC}{\tau} = \frac{1}{M} + 2BC$$

where, B = Second virial coefficient

C = Concentration of the solution

R_{90} = Rayleigh ratio at 90° observation angle. This ratio in a generalised case is represented as R_θ .

τ = Turbidity of the medium which results from the scattering of light.

H and K = Light-scattering calibration constants and are defined as follows :

$$K = \frac{2\pi^2 n^2 (dn/dc)^2}{\lambda^4 N_A}$$

where, π = mathematical symbol with a value 3.14.

n = refractive index of the solution

dn/dc = specific refractive index increment, *i.e.*, the change of refractive index with concentration

λ = wavelength of incident light

N_A = Avogadro's number

$$H = \frac{32\pi^3 n^2 (dn/dc)^2}{3\lambda^4 N_A}$$

Again, the Rayleigh ratio is determined at an observation angle of 90° . Hence,
 $R_\theta = R_{90^\circ}$

According to Rayleigh, $R_\theta = \frac{i_\theta r^2}{I_0 V}$

where, i_θ = intensity of the scattered light per unit volume V

V = volume

r = scattering material distance

θ = angle with reference to the incident beam.

I_0 = Intensity of the incident beam

DNA

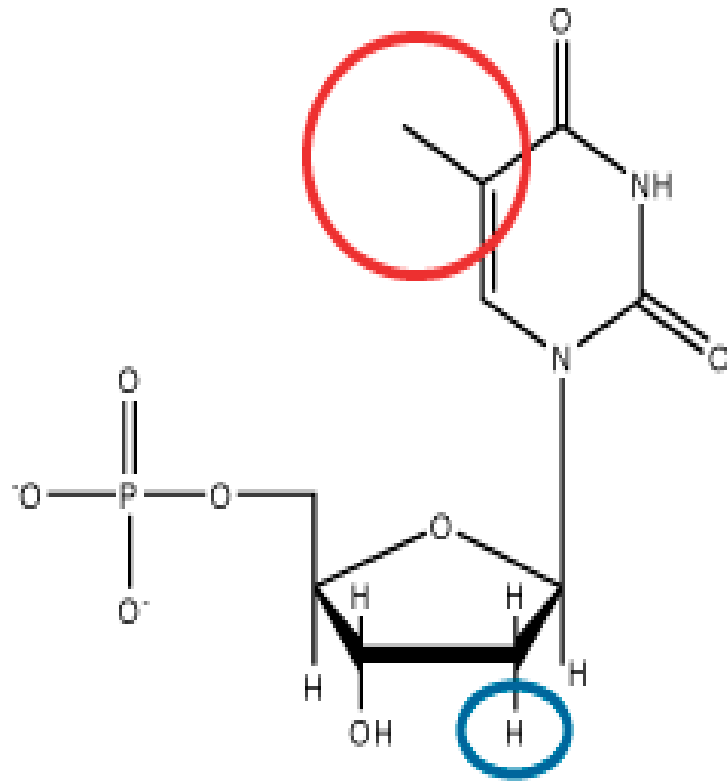

RNA

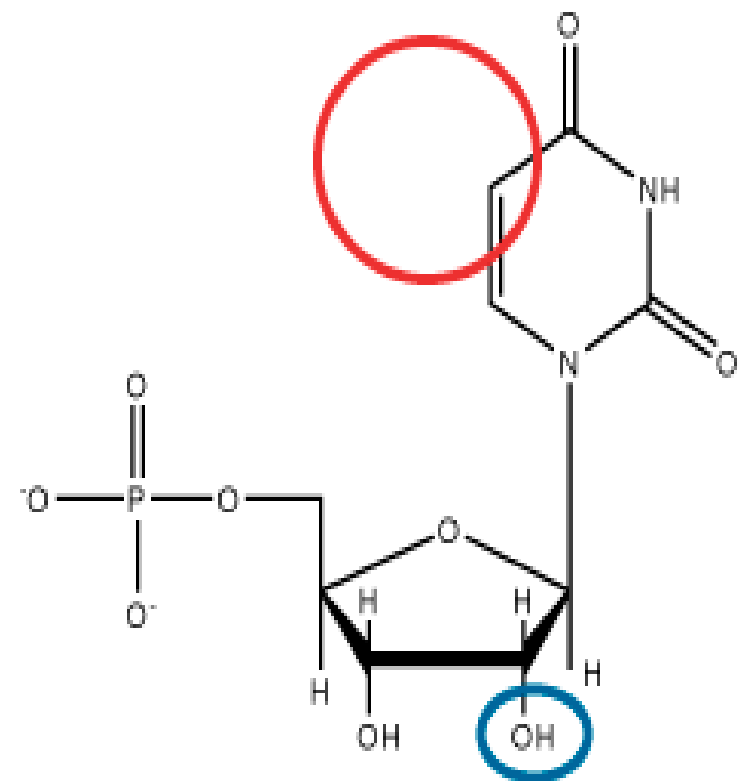

There are two differences between the structure of DNA (on the left) and RNA (on the right). DNA contains a sugar group with a 2' hydrogen, while RNA contains a 2' hydroxyl group (circled in blue). DNA contains the base thymine, which base pairs with adenine. Instead of thymine, RNA contains a related base called uracil. Uracil is similar to thymine but lacks a methyl group (circled in red). Like thymine, uracil can base pair with adenine.

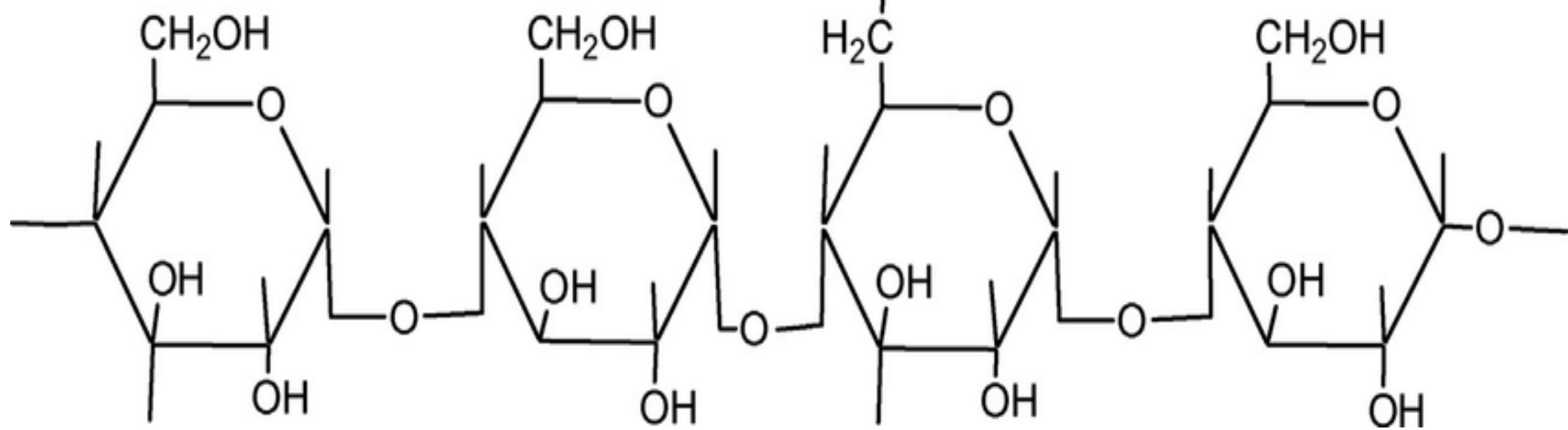
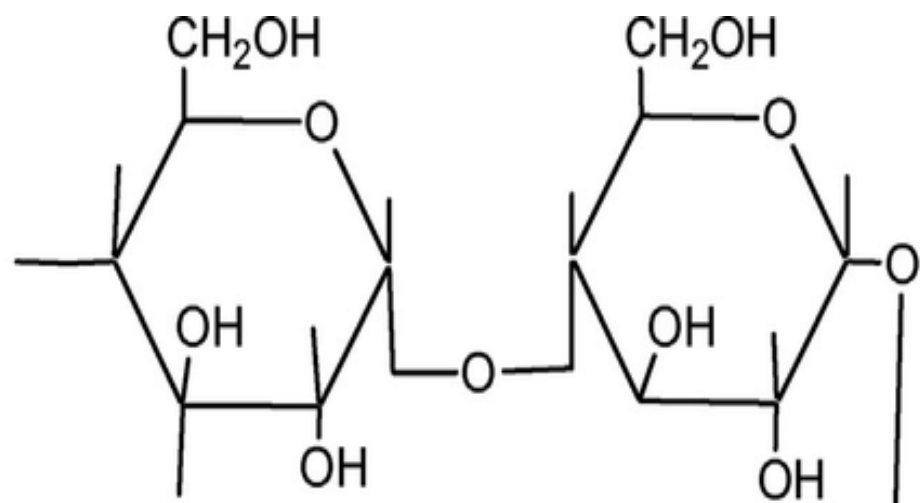

Structure of glycogen

* Glycogen: branched-chain homopolysaccharide made of α -D-glucose linked by α -1,4 linkage.

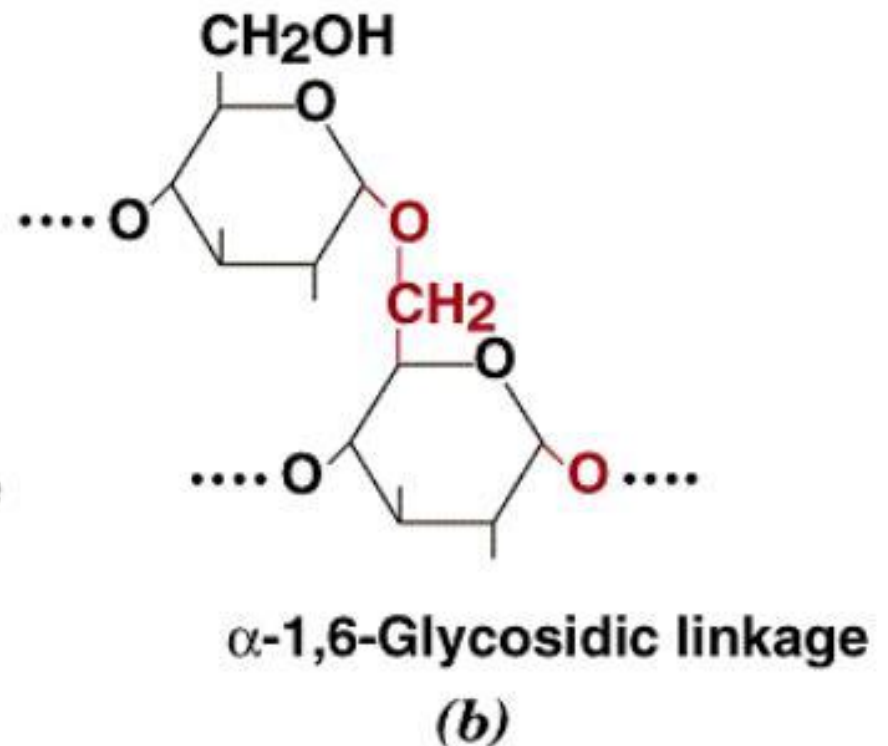
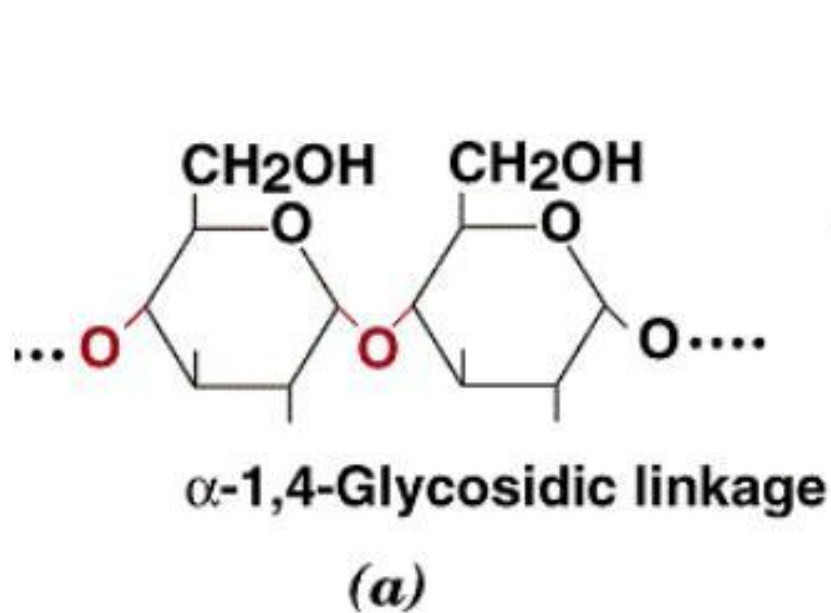

After every 8-10 glucose residues there is a branch containing α -1,6 linkage.