

THE LYMPHATIC SYSTEM

Where Are T Cells And B Cell Made?

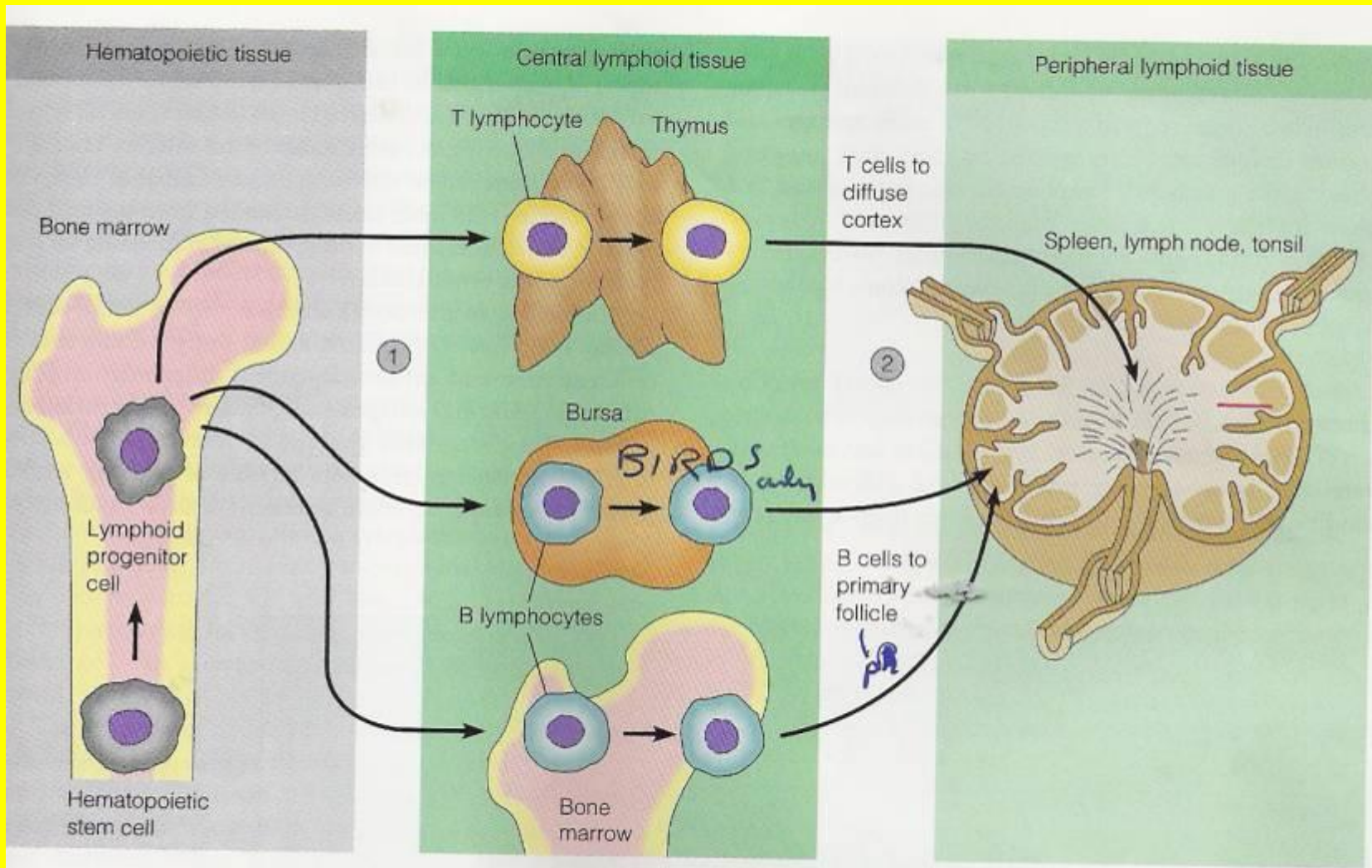

Maturation of the immune response

- **Lymphoid organs are separated into primary and secondary organs**
 - **Primary--> bone marrow, thymus**
 - **Secondary or peripheral--> lymphnodes, spleen, mucosal lymphoid tissues (GALT, MALT), provide sites for mature lymphocytes to interact with antigen**

Different organs of the immune system

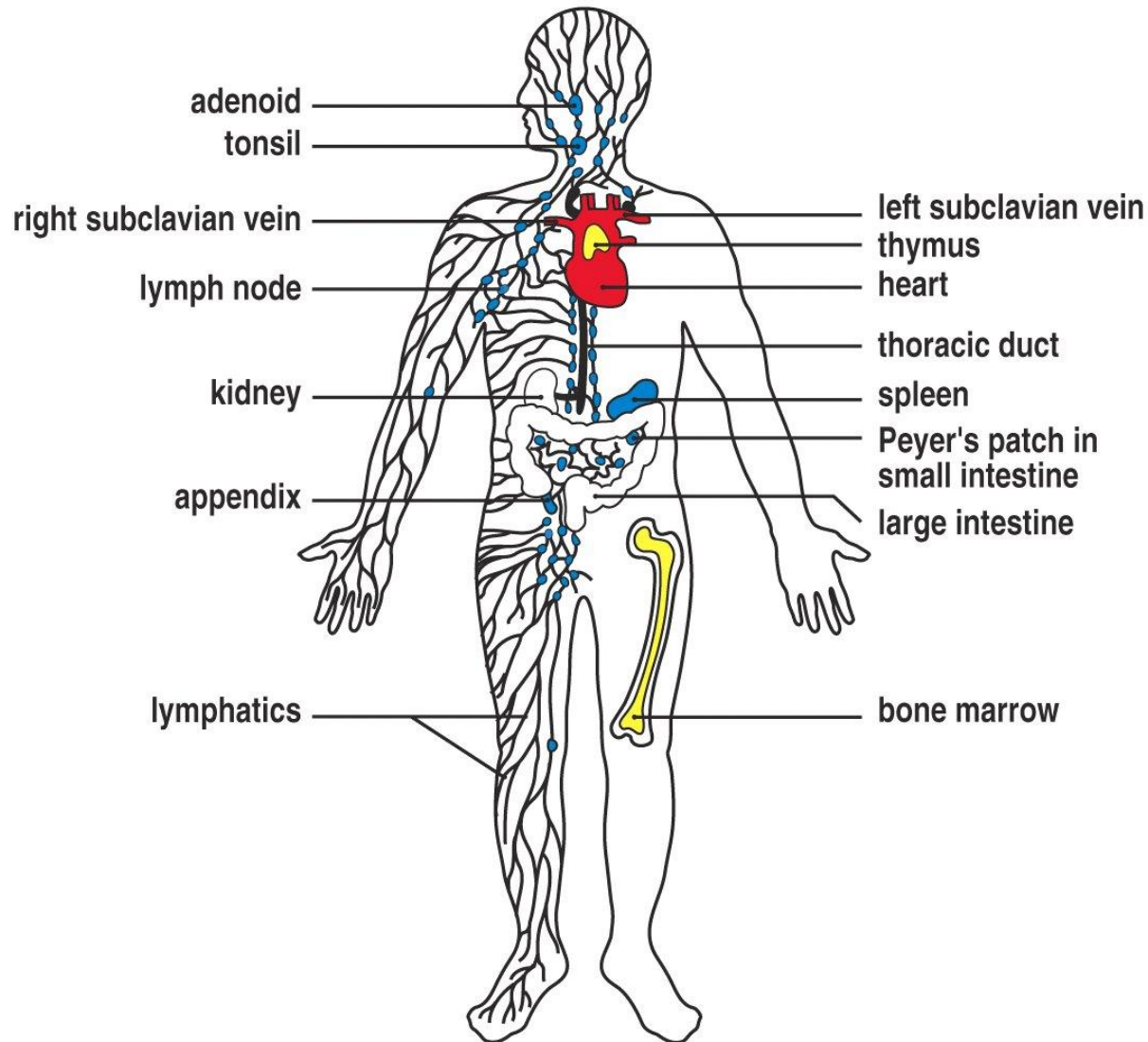

Figure 1-7 Immunobiology, 6/e. (© Garland Science 2005)

The role of bone marrow in immune maturation

- **Microenvironment for differentiation of stem cells**
- **Site of origin of B and T lymphocytes, all other cells of the immune response**
- **“Antigen-independent” maturation of B cells.**
- **Site for mature re-circulating lymphocyte populations**

Bone Marrow

- **Cells move out of Bone Marrow into blood**
- **The bursa in the bird plays the same role for B cell maturation; appendix in rabbit**

Thymus

- The thymus is a bi-lobed organ above the heart
- Each lobe is surrounded by a capsule and divided into lobules which are separated from each other via connective tissue called trabeculae
- Each lobe is organized into 2 compartments
- The outer component is the cortex (packed with immature T cells)
- The inner component is the medulla (sparsely populated with more mature thymocytes)
- Criss-crossing the entire organ is a stromal network of epithelial cells, DCs and macrophages
- These cells participate in positive and negative selection of T cells
- Over 95% of the T cells that enter the thymus die by apoptosis within the thymus without reaching maturity
- The thymus involutes with age

Thymus Location

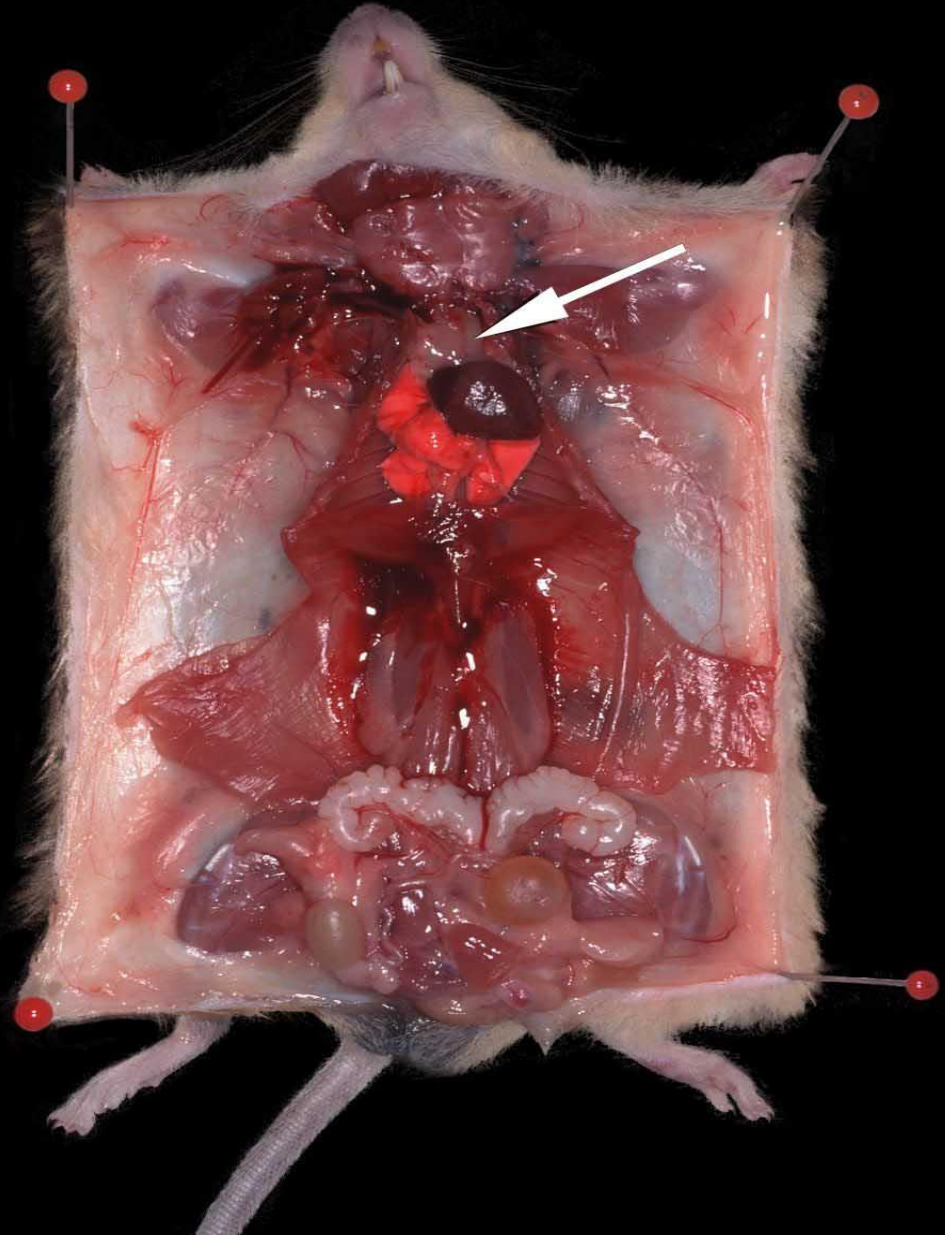
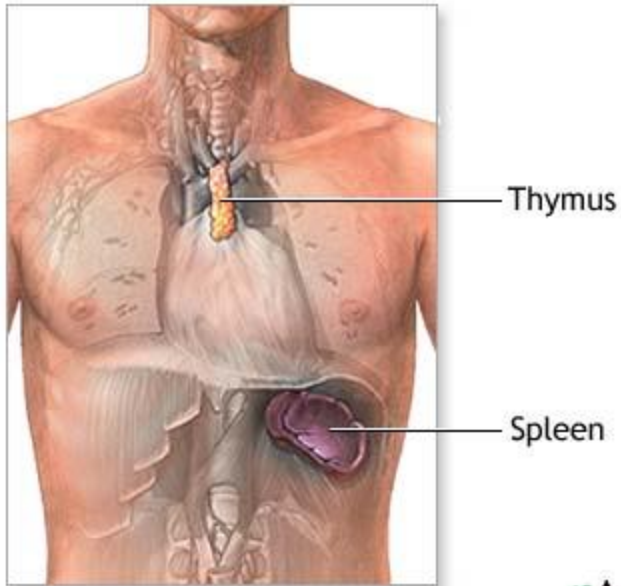
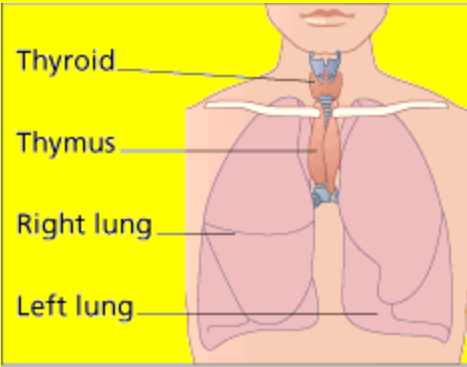

Adult THYMUS

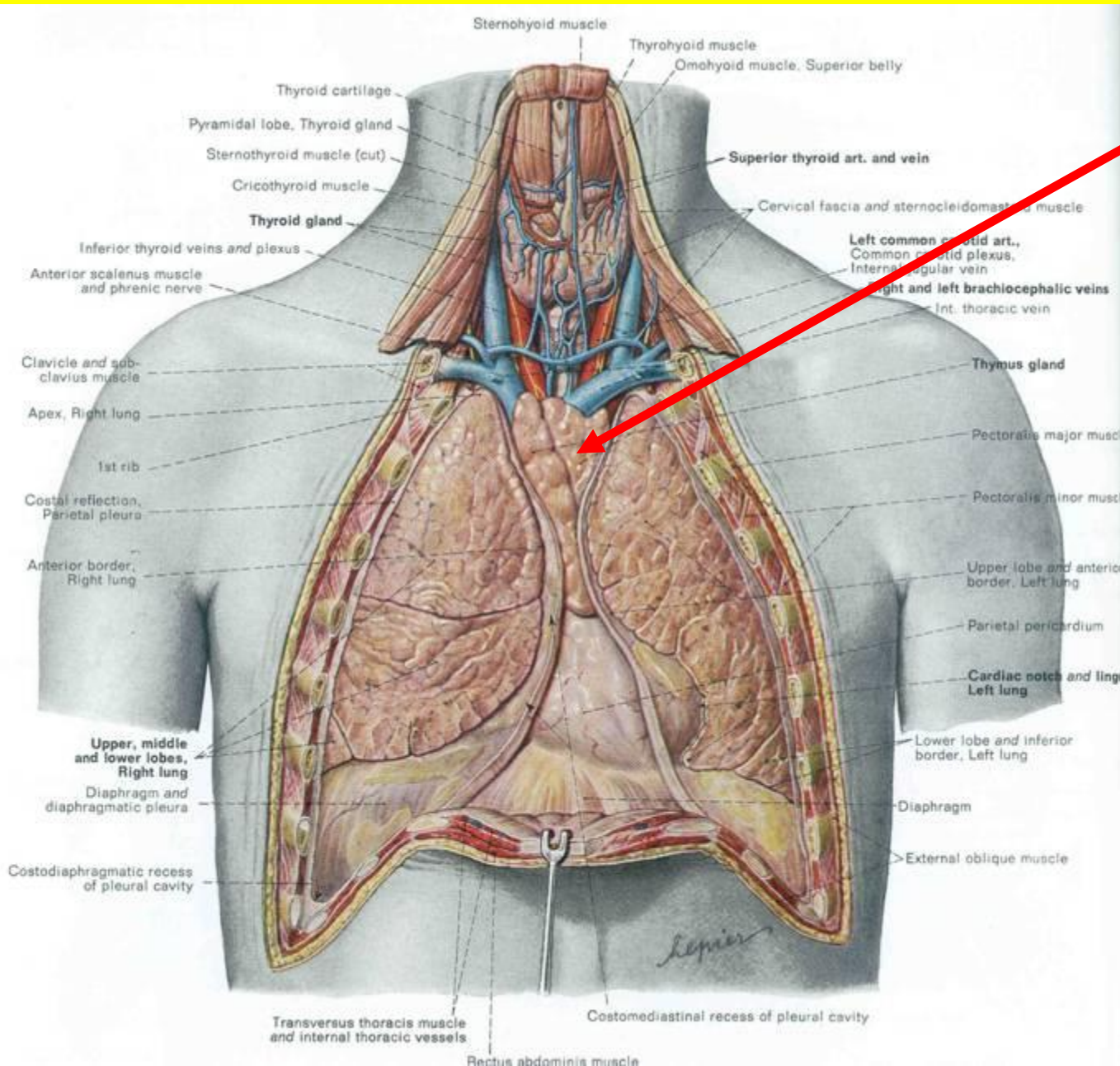

One-year old THYMUS

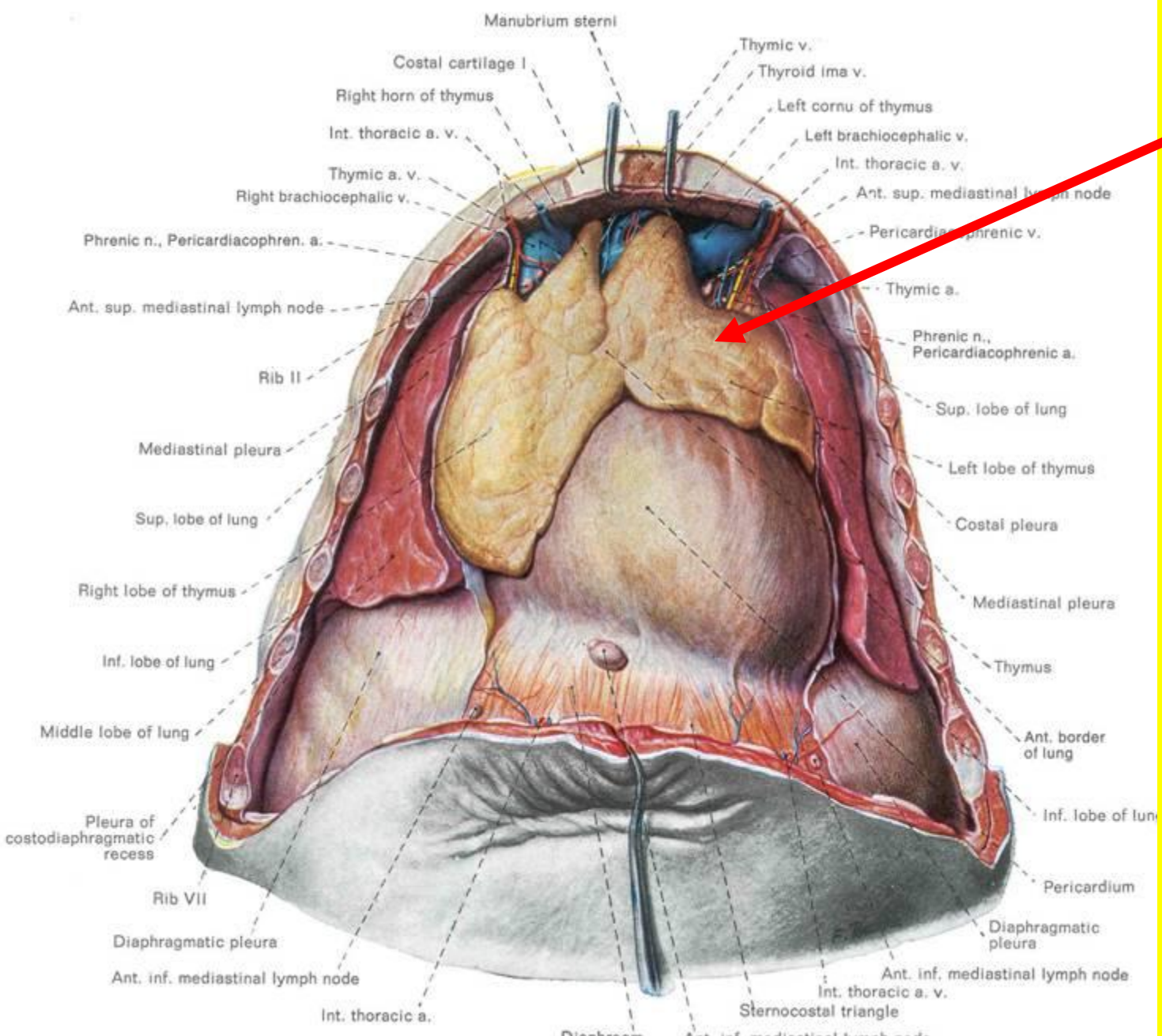

The Thymus

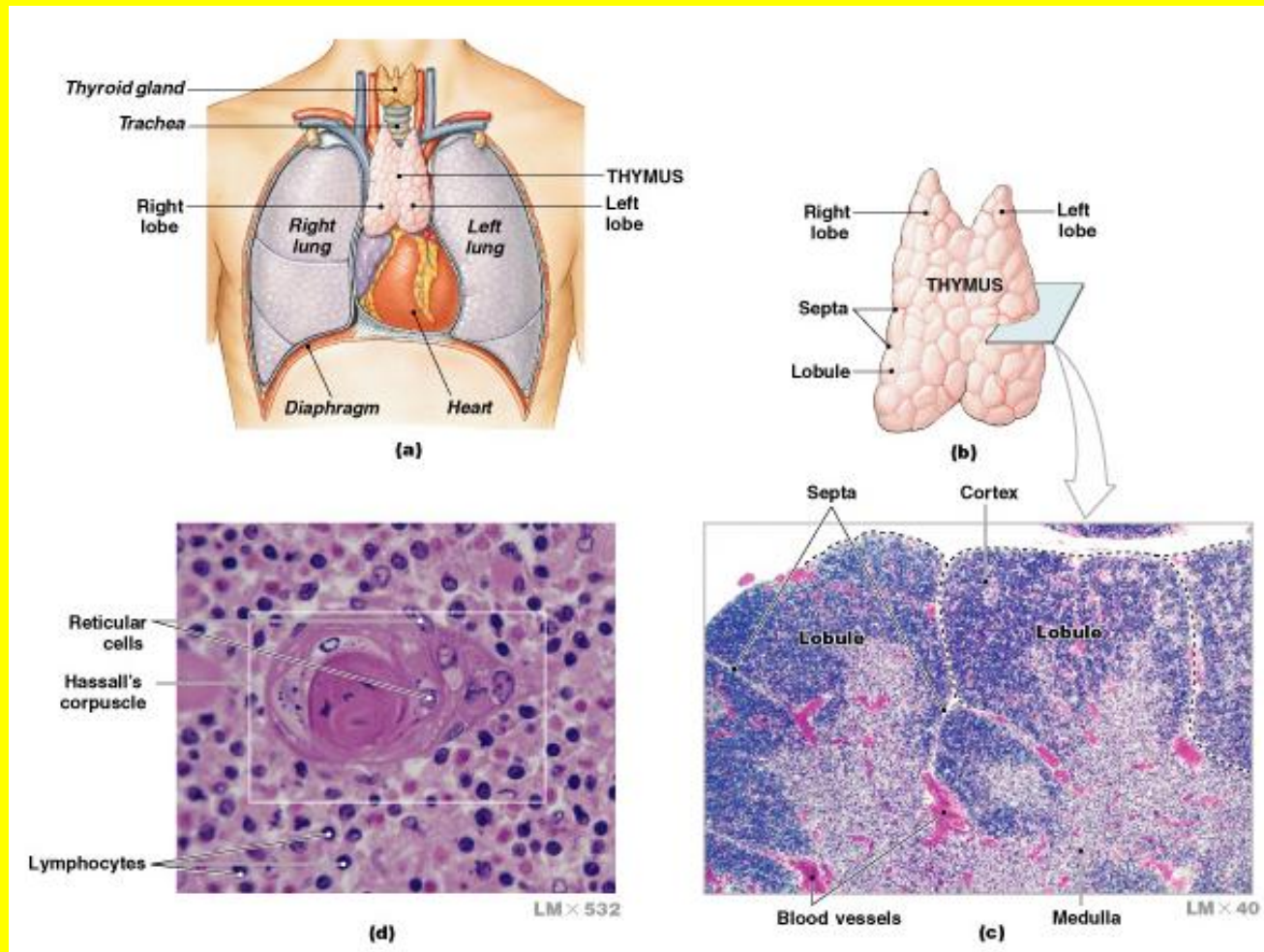

Figure 22-8

Thymus-structure/function

- **Thymic stroma-->**
network of epithelia-
contains T cell precursors.
- **Dendritic cells,**
macrophage and
medullary epithelial cells
in thymic medulla
- **Sub-capsular epithelium**
underlying capsule-acts
as barrier



The Thymus





capsule

trabecula

Cortex

Medulla

Hassall's corpuscles
(degenerating layers of
Epithelial cells)

-  **Thymocytes**
-  **Cortical epithelial cells**
-  **Medullary epithelial cells**
-  **Dendritic cells (BM origin)**
-  **Macrophages**

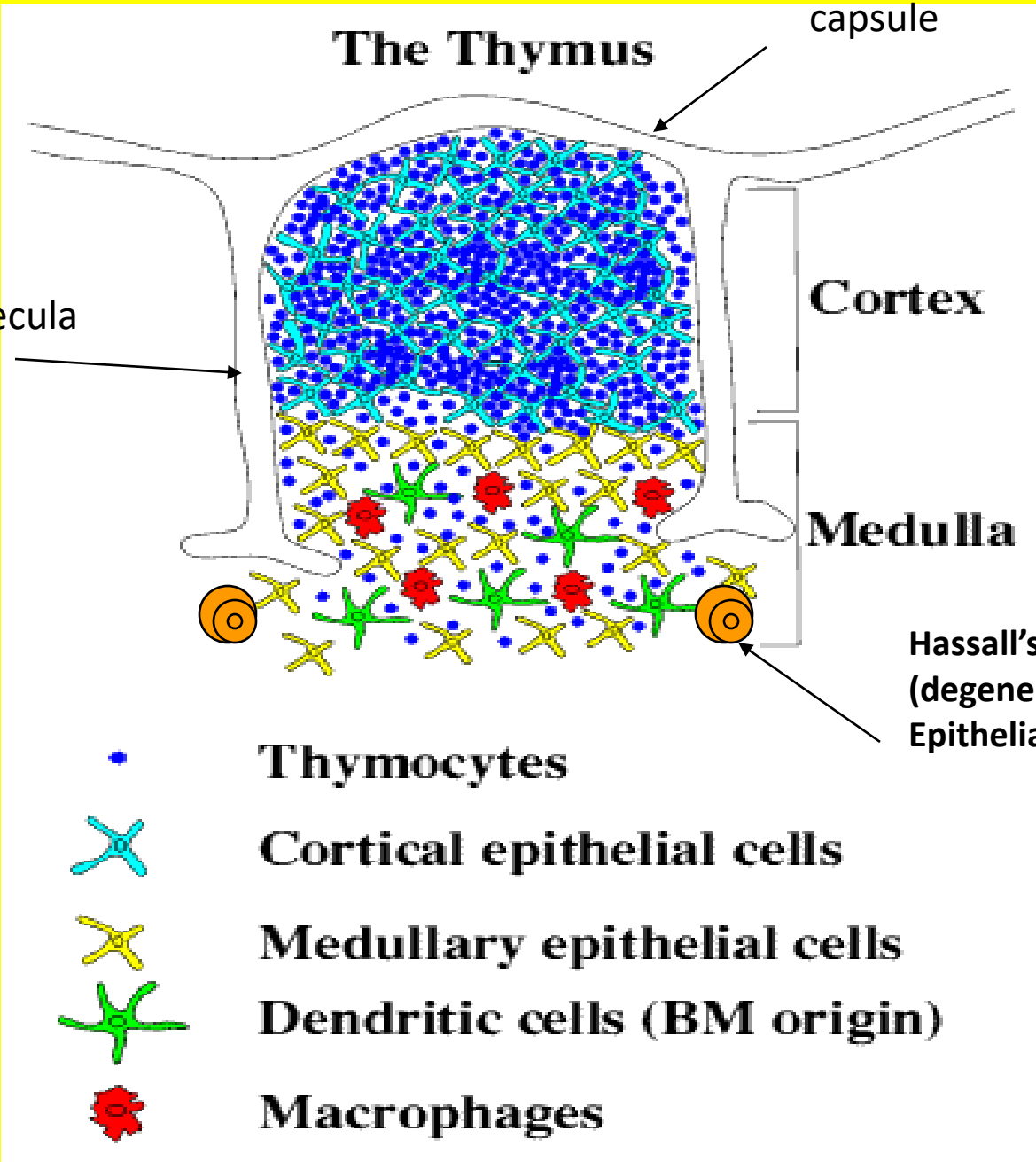

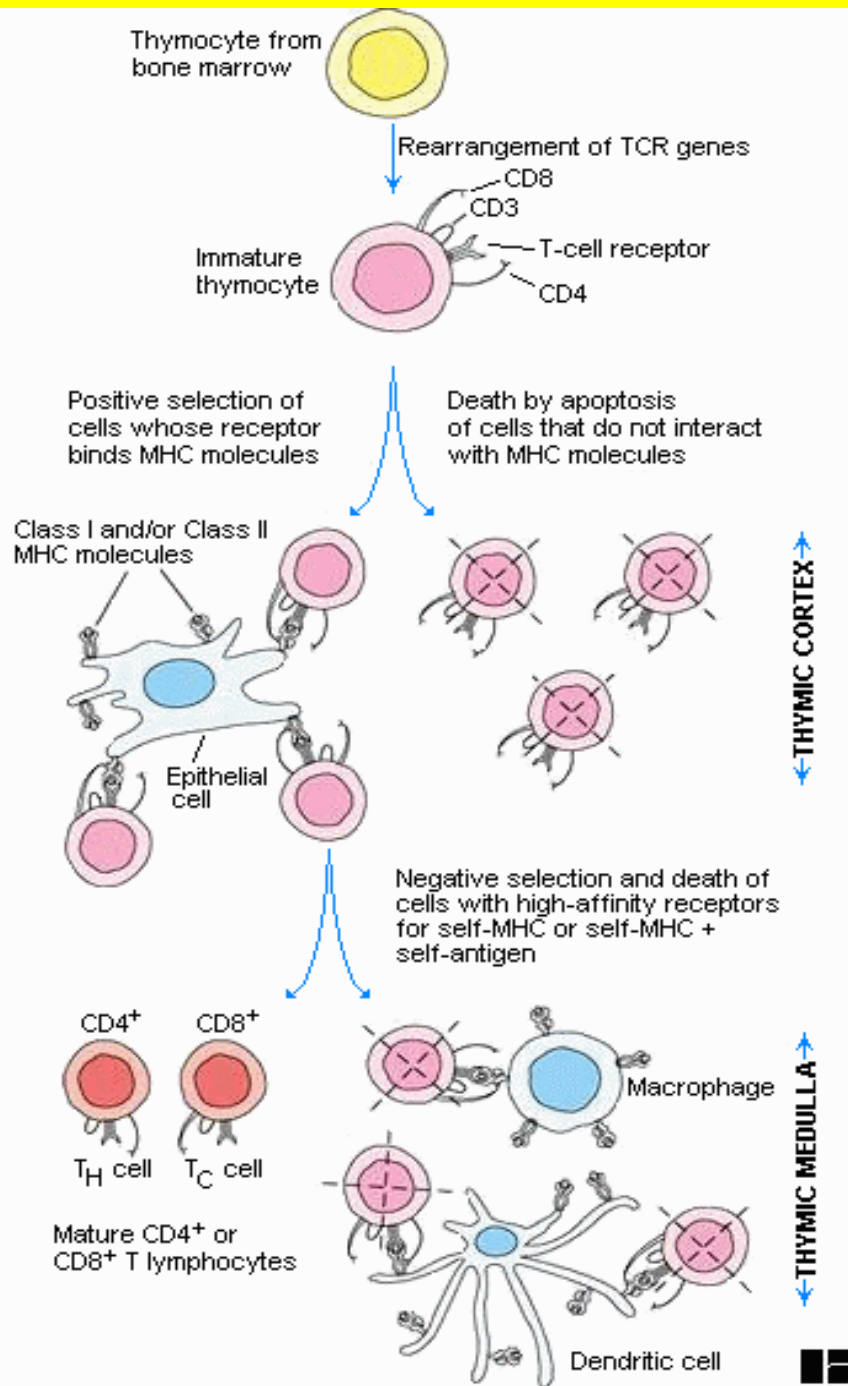

Schematic diagram of T cell maturation within the thymus

Summary of Thymic Development

Anderson and Jenkinson, NRI, 2001

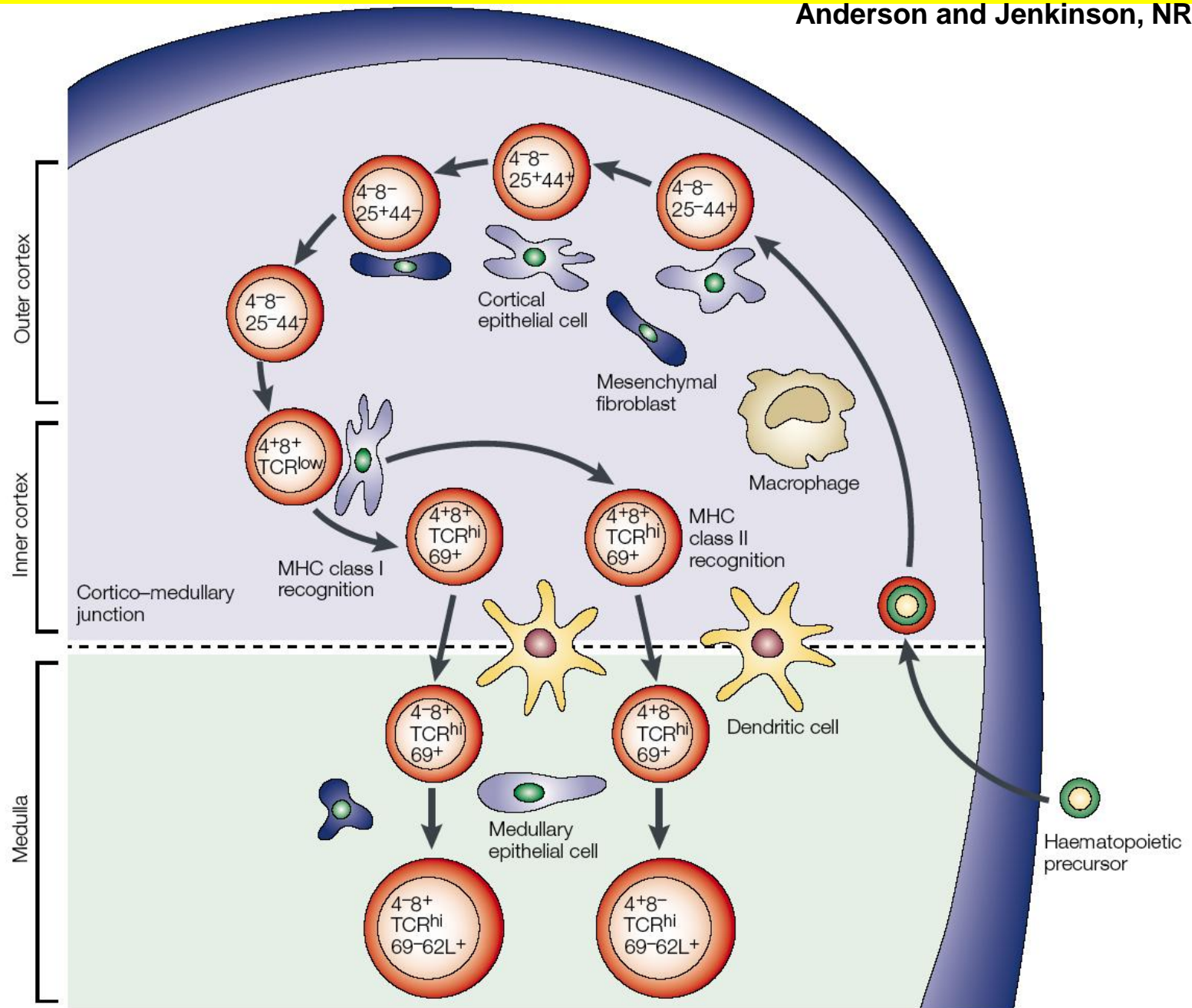

Major Thymocyte Subsets

CD4⁻CD8⁻ (Double Negative, DN) cells: 3-5% of total thymocytes

Contain least mature cells, considerable cell division

2/3rds are triple negative (TN) based on TCR expression

Can be further divided based on CD44 and CD25 (discussed later)

TCR β, γ and δ rearrangements occur at this stage

1/3rd are TCR $\gamma\delta^+$

CD4⁺CD8⁺ (Double Positive, DP) cells: 80-85% of total thymocytes

TCR α rearrangement occurs at this stage

Most have rearranged TCR $\alpha\beta$ genes & express low levels (10% mature level) of TCR

Small subset has high levels of TCR (most mature, positively selected cells)

Small subset is actively dividing (earliest DPs)

Most apoptosis occurs here, very sensitive to apoptosis inducing agents,
especially sensitive to glucocorticoids

CD4⁺CD8⁻ and CD4⁻CD8⁺ (Single positive, SP) cells: 10-15% of total thymocytes

Most are mature cells with high levels of CD3 and TCR $\alpha\beta$

CD4:CD8 approx 2:1 ratio

Most SP cells are functionally mature and are destined to leave the thymus

Small subset of SP are immature (ISP) (CD8 in mouse, CD4 in human) and have
low CD3 and no TCR $\alpha\beta$ - transitional cells that are on the way from DN -> DP

Major Phenotypes and Subsets of T Cell Development

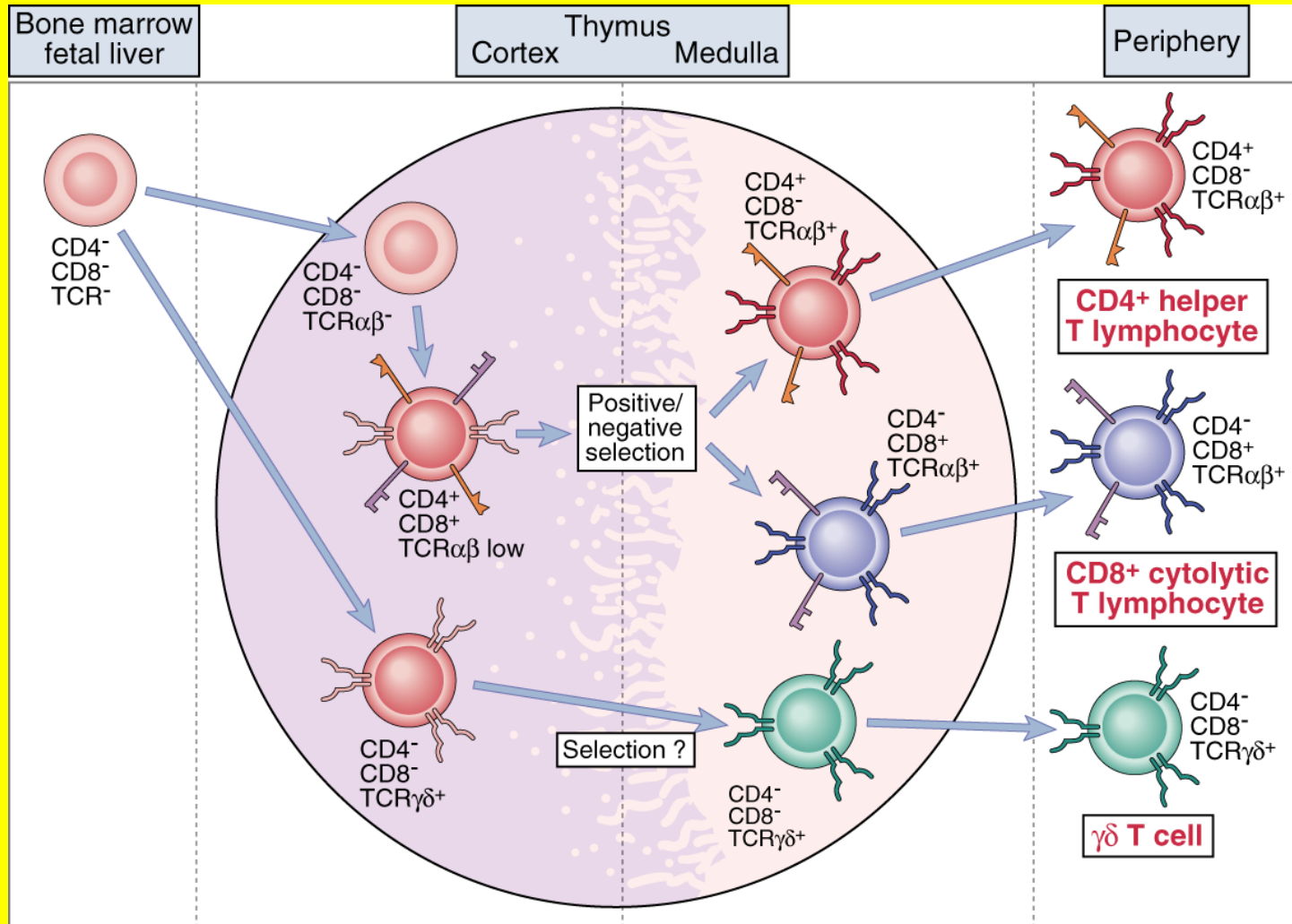

T cells

T_C cell

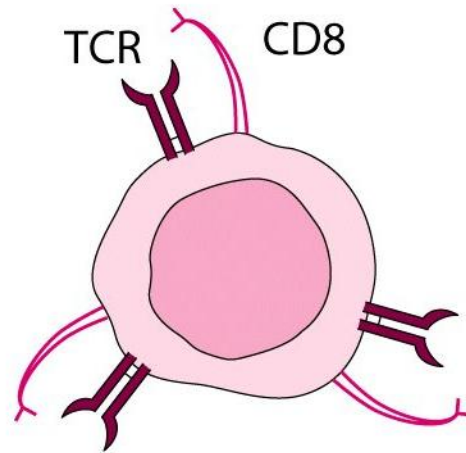

Recognizes MHC I
on all cells

Kills:

Infected cells
Tumour cells

T_H cell

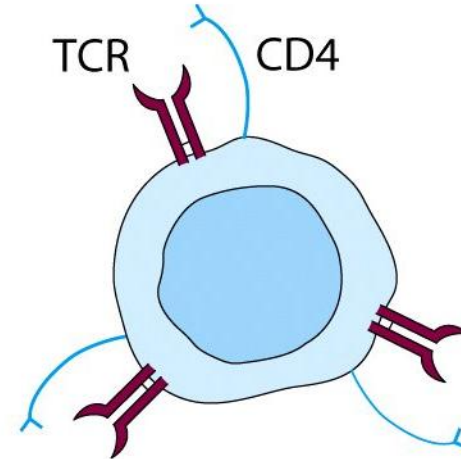

Recognizes MHC II
on APC

Helps:

B-cells
T cells
Macrophages

Accessory Molecules

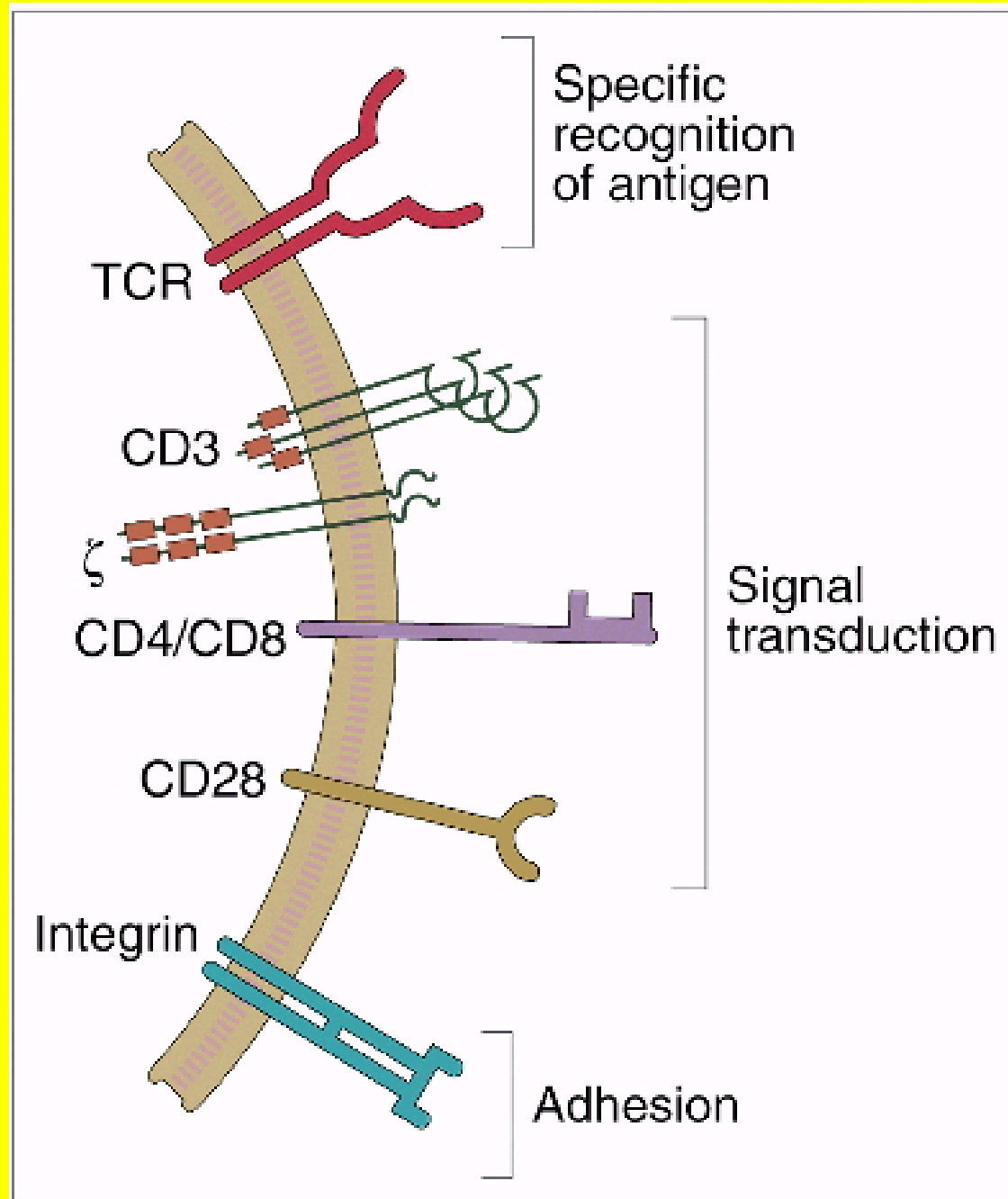

Two classes of T-cell receptor

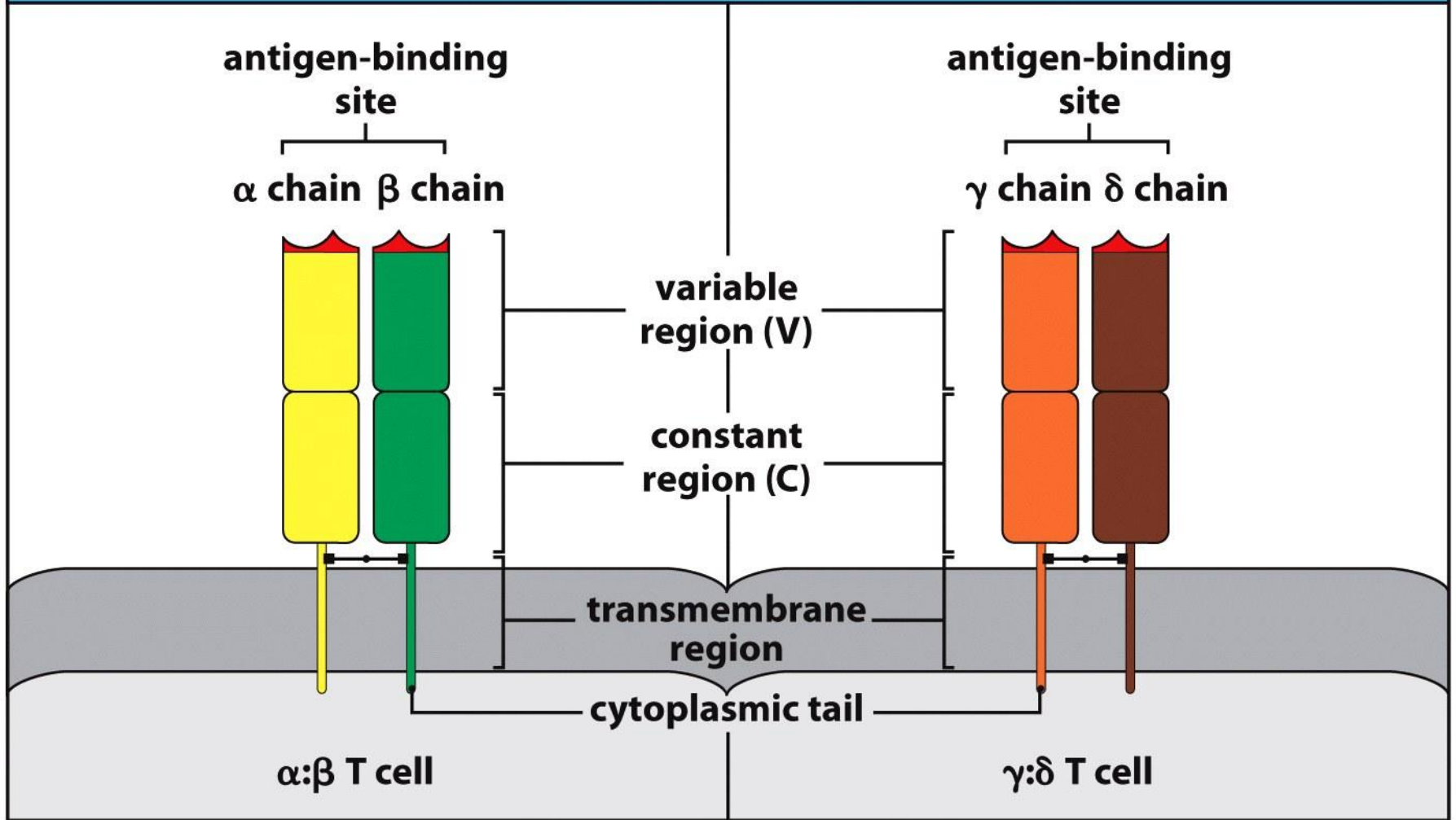
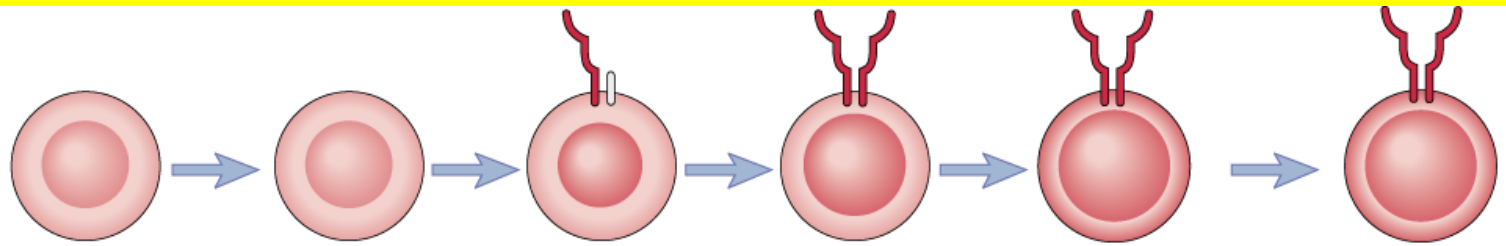
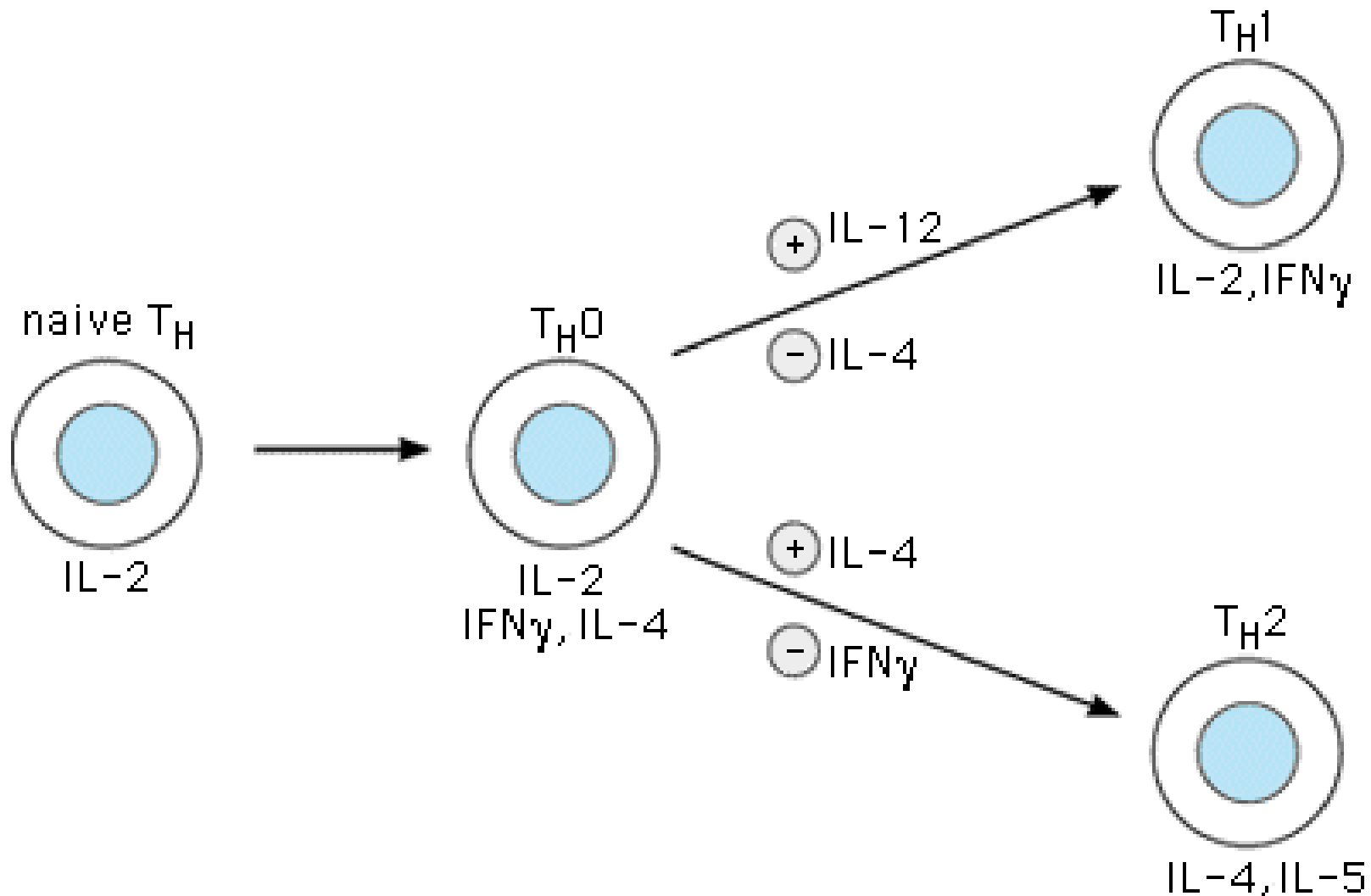

Figure 5.7 The Immune System, 3ed. (© Garland Science 2009)



Stage of maturation	Stem cell	Pro-T	Pre-T	Double positive	Single positive (immature T cell)	Naive mature T cell
Proliferation	[Orange bar]			[Orange bar]		
RAG expression			[Orange bar]	[Orange bar]		
TdT expression		[Orange bar]				
TCR DNA, RNA	Unrecombined (germline) DNA	Unrecombined (germline) DNA	Recombined β chain gene [V(D)J-C]; β chain mRNA	Recombined β , α chain genes [V(D)J-C]; β and α chain mRNA	Recombined β , α chain genes [V(D)J-C]; β and α chain mRNA	Recombined β , α chain genes [V(D)J-C]; β and α chain mRNA
TCR expression	None	None	Pre-T receptor (β chain/pre-T α)	Membrane $\alpha\beta$ TCR	Membrane $\alpha\beta$ TCR	Membrane $\alpha\beta$ TCR
Surface markers	$c\text{-kit}^+$ CD44 ⁺ CD25 ⁻	$c\text{-kit}^+$ CD44 ⁺ CD25 ⁺	$c\text{-kit}^+$ CD44 ⁺ CD25 ⁺	CD4 ⁺ CD8 ⁺ TCR/CD3 ^{lo}	CD4 ⁺ CD8 ⁻ or CD4 ⁻ CD8 ⁺ TCR/CD3 ^{hi}	CD4 ⁺ CD8 ⁻ or CD4 ⁻ CD8 ⁺ TCR/CD3 ^{hi}
Anatomic site	Bone marrow	Thymus				Periphery
Response to antigen	None	None	None	Positive and negative selection	Negative selection	Activation (proliferation and differentiation)

T cells



CD2

- CD2 is a glycoprotein present on more than 90% of mature T-cells and 50-70% of thymocytes.
- This molecule contains two extracellular Ig domains.
- The principle ligand for CD2 is LFA-3 (CD58).

CD2

- CD2 functions both as an adhesion molecule and signal transducer.
- The association of CD2 with the TCR complex helps to aggregate the TCR in the regions of cell–cell contact, allowing the stabilization of low-affinity TCR/MHC interactions.
- Finally, CD2 is involved in the regulation of cytokine production by T cells.
- Stimulation via the CD2 pathway can skew the cytokine profile toward a TH2-like phenotype.

CD3

- TCRs occur as either of two distinct heterodimers, $\alpha\beta$ or $\gamma\delta$, both of which are expressed with the non-polymorphic polypeptides γ , δ , ϵ , and ζ .
- The CD3 polypeptides, especially ζ and its variants, are critical for intracellular signaling.

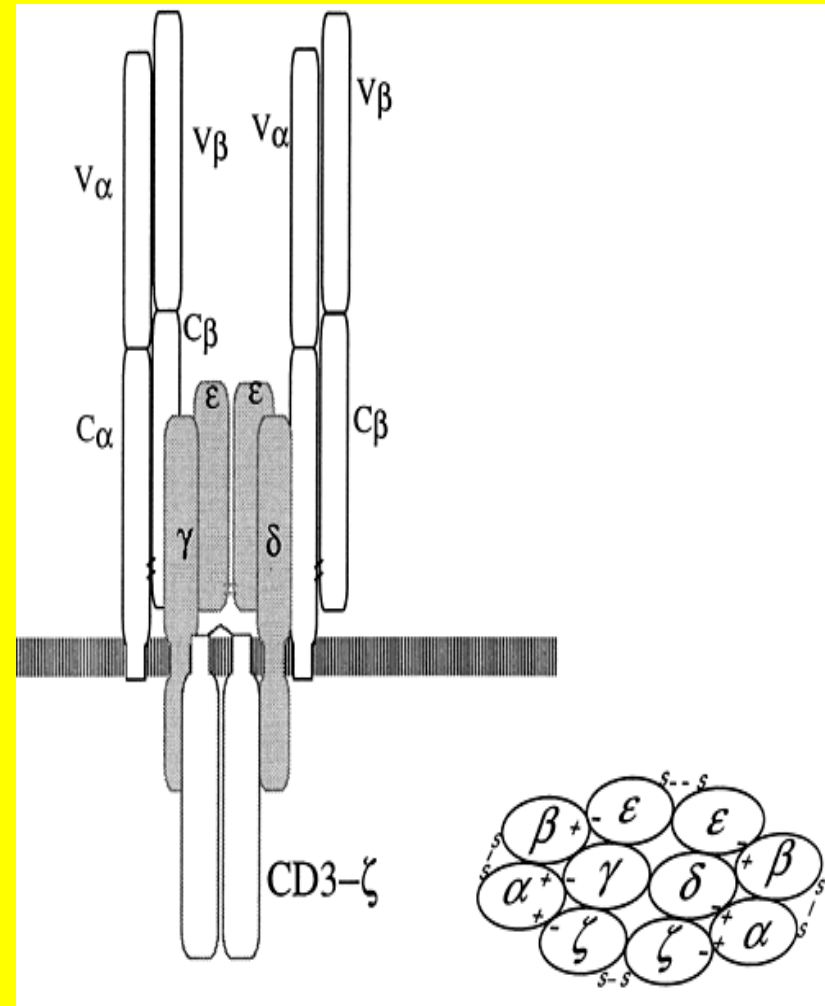

TABLE 9-1**Comparison of $\alpha\beta$ and $\gamma\delta$ T cells**

Feature	$\alpha\beta$ T cells	$\gamma\delta$ T cells
Proportion of CD3 ⁺ cells	90–99%	1–10%
TCR V gene germ-line repertoire	Large	Small
CD4/CD8 phenotype		
CD4 ⁺	~60%	<1%
CD8 ⁺	~30%	~30%
CD4 ⁺ CD8 ⁺	<1%	<1%
CD4 ⁻ CD8 ⁻	<1%	~60%
MHC restriction	CD4 ⁺ : MHC class II CD8 ⁺ : MHC class I	No MHC restriction
Ligands	Peptide + MHC	Phospholipid antigen

SOURCE: D. Kabelitz et al., 1999, *Springer Seminars in Immunopathology* 21:55, p. 36.

TCR Accessory Molecules

TABLE 9-4 Selected T-cell accessory molecules

Name	Ligand	FUNCTION		
		Adhesion	Signal transduction	Member of Ig superfamily
CD4	Class II MHC	+	+	+
CD8	Class I MHC	+	+	+
CD2 (LFA-2)	CD58 (LFA-3)	+	+	+
LFA-1 (CD11a/CD18)	ICAM-1 (CD54)	+	?	+ / (-)
CD28	B7	?	+	+
CTLA-4	B7	?	+	-
CD45R	CD22	+	+	+
CD5	CD72	?	+	-

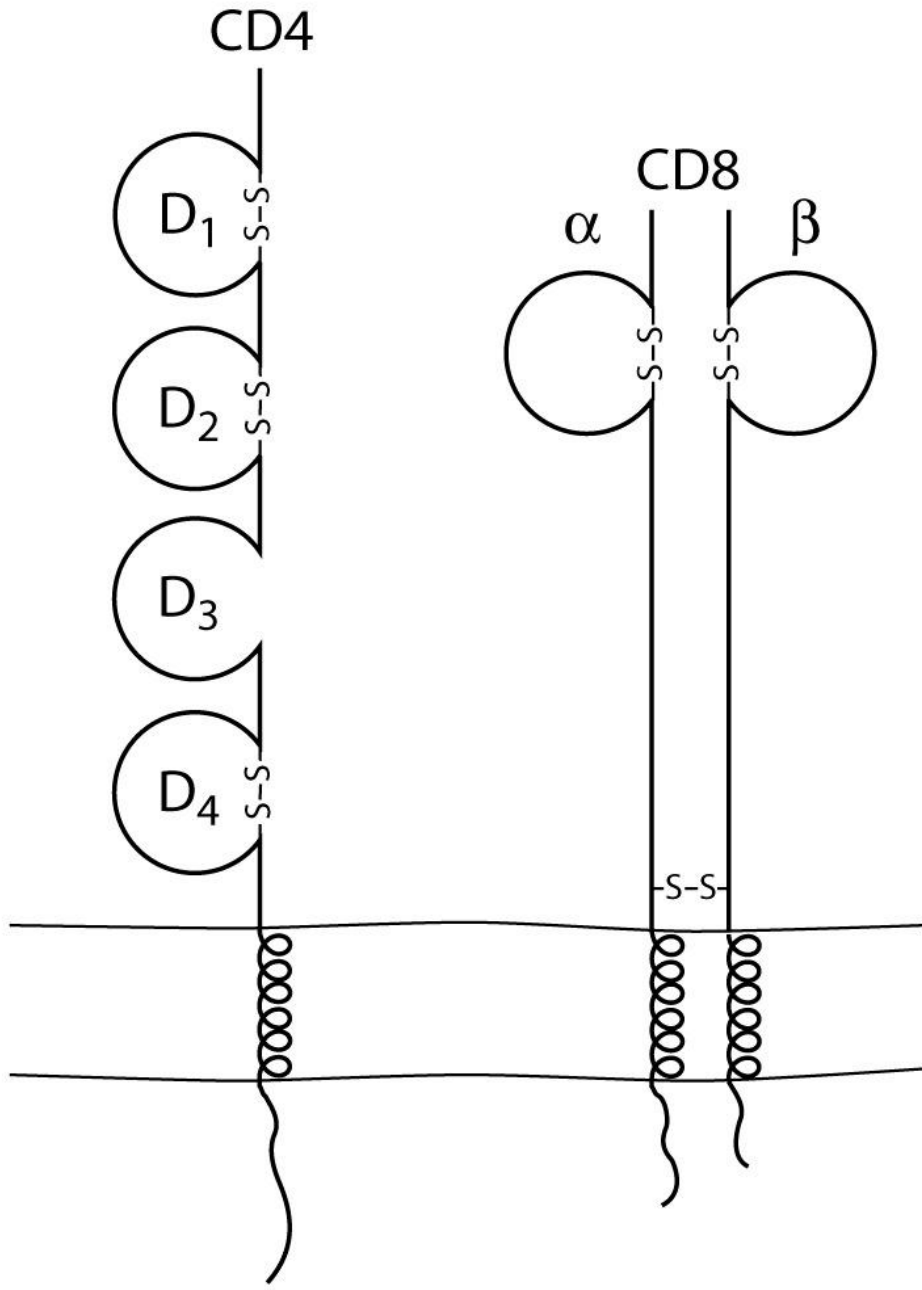

Diseases related to Thymic Defects

- DiGeorge's syndrome-congenital birth defect in humans; no functional thymus
- Nude mice-fail to develop a thymus
- Experimentally, you can thymectomize mice at a young age as well.

Bone Marrow

1. The site of generation of all immune and blood cells
<= **Hematopoietic Stem Cell**
2. Provides **Cell-cell interactions** and **Cytokines** for the development of all immune cells.
<= **Stromal reticular cells & other cells**

Bone marrow

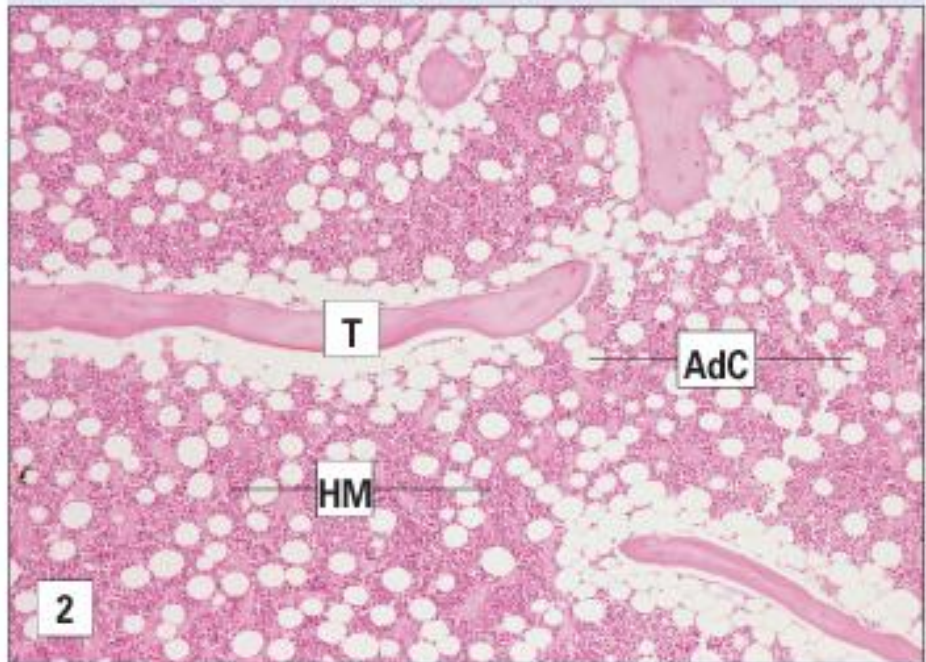
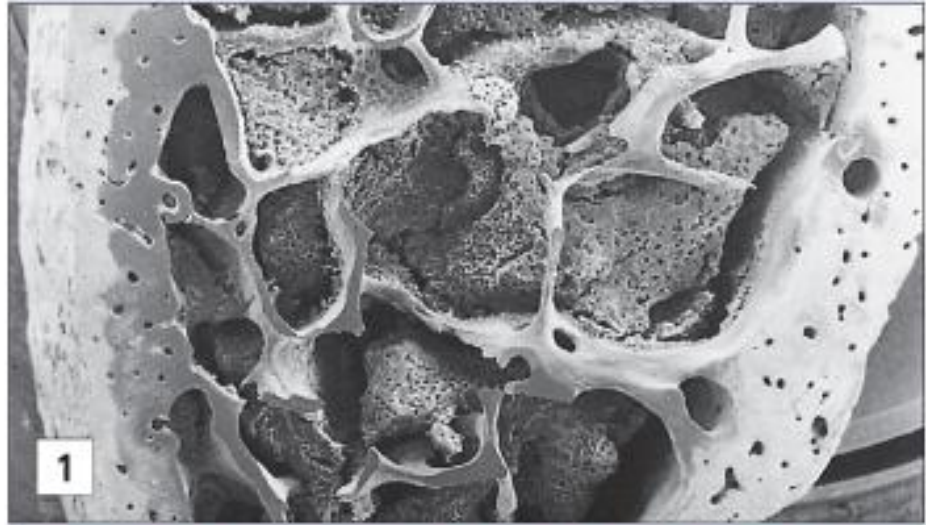

B cell development in the Bone Marrow

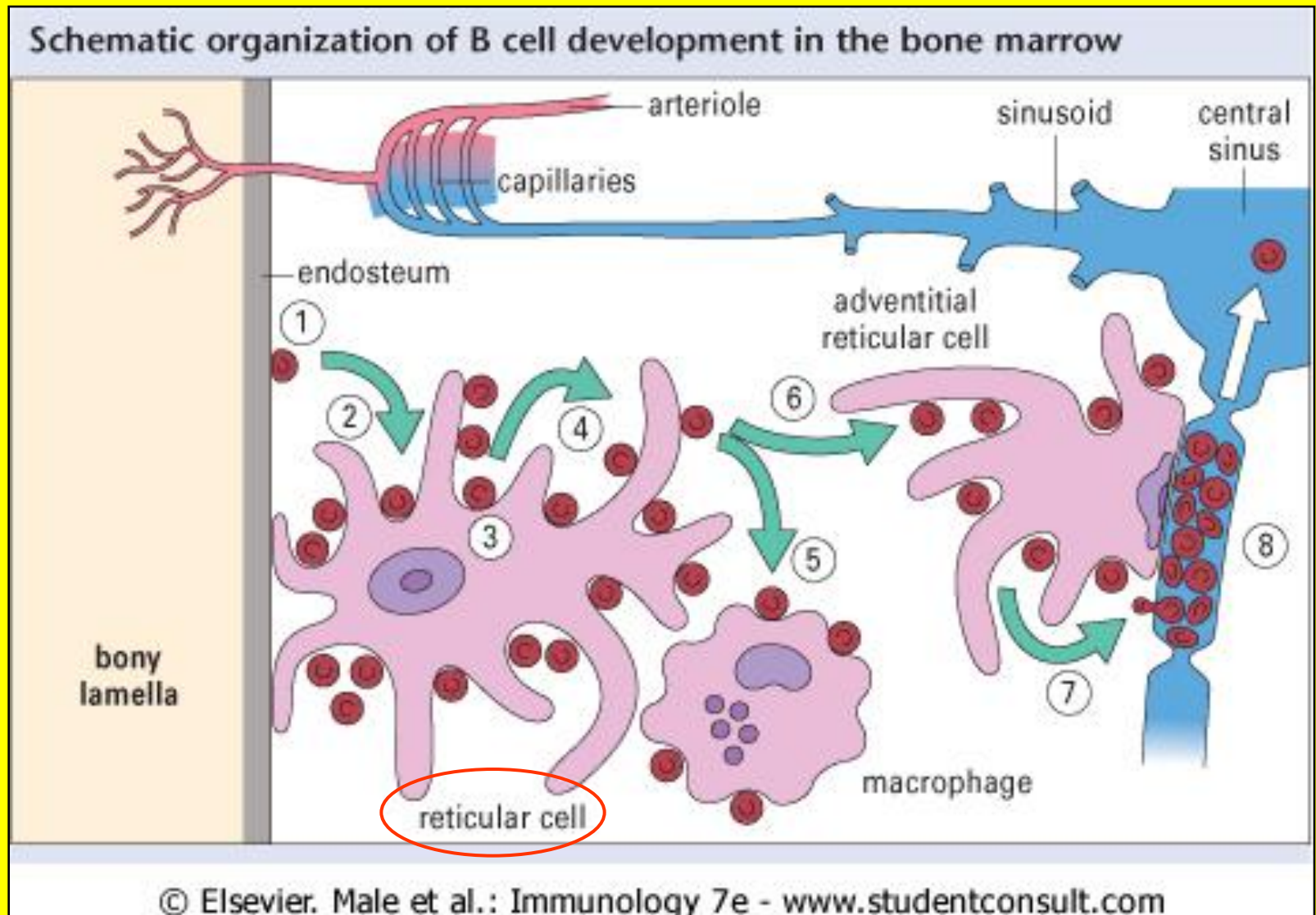

Bone marrow stromal cells drive Pro-B cell proliferation and maturation.

Important molecules and interactions:
SCF-cKit
IL-7-IL-7R

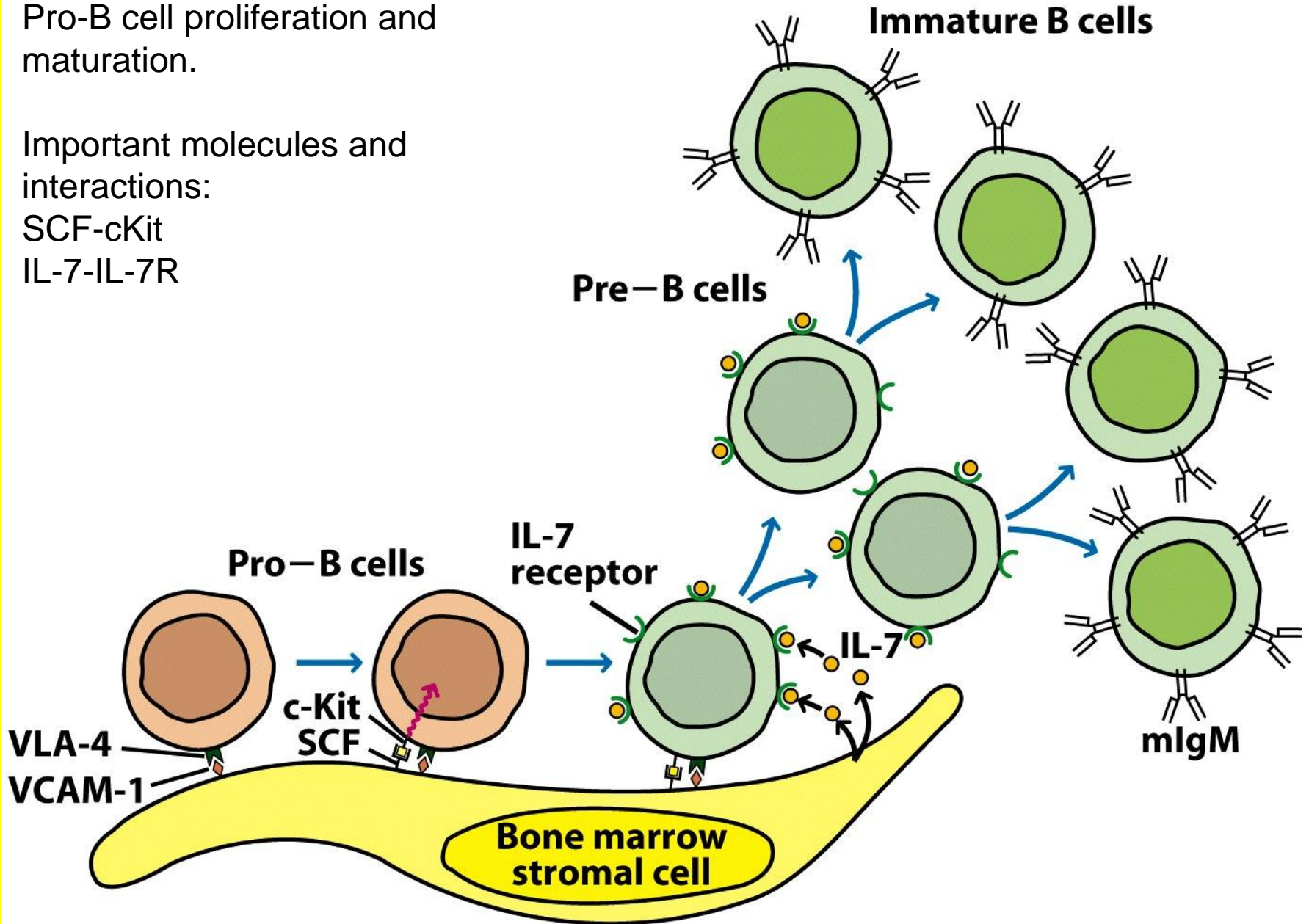
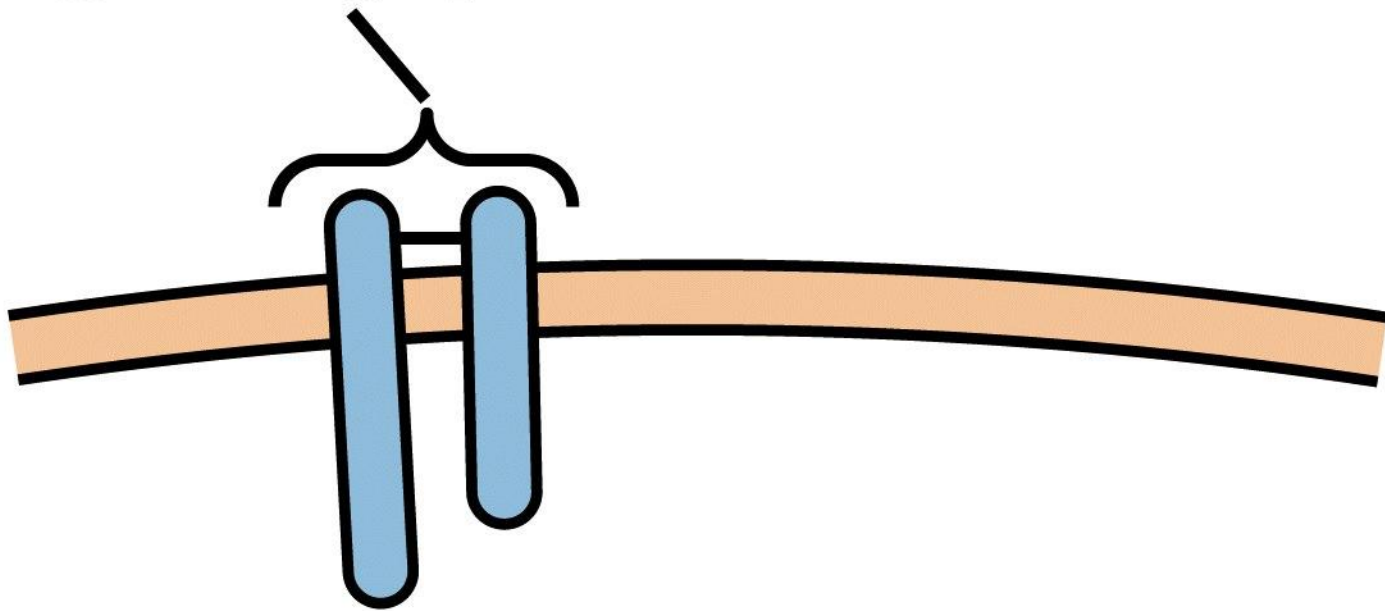

Figure 11-2

Pro-B cell

Ig- α /Ig- β



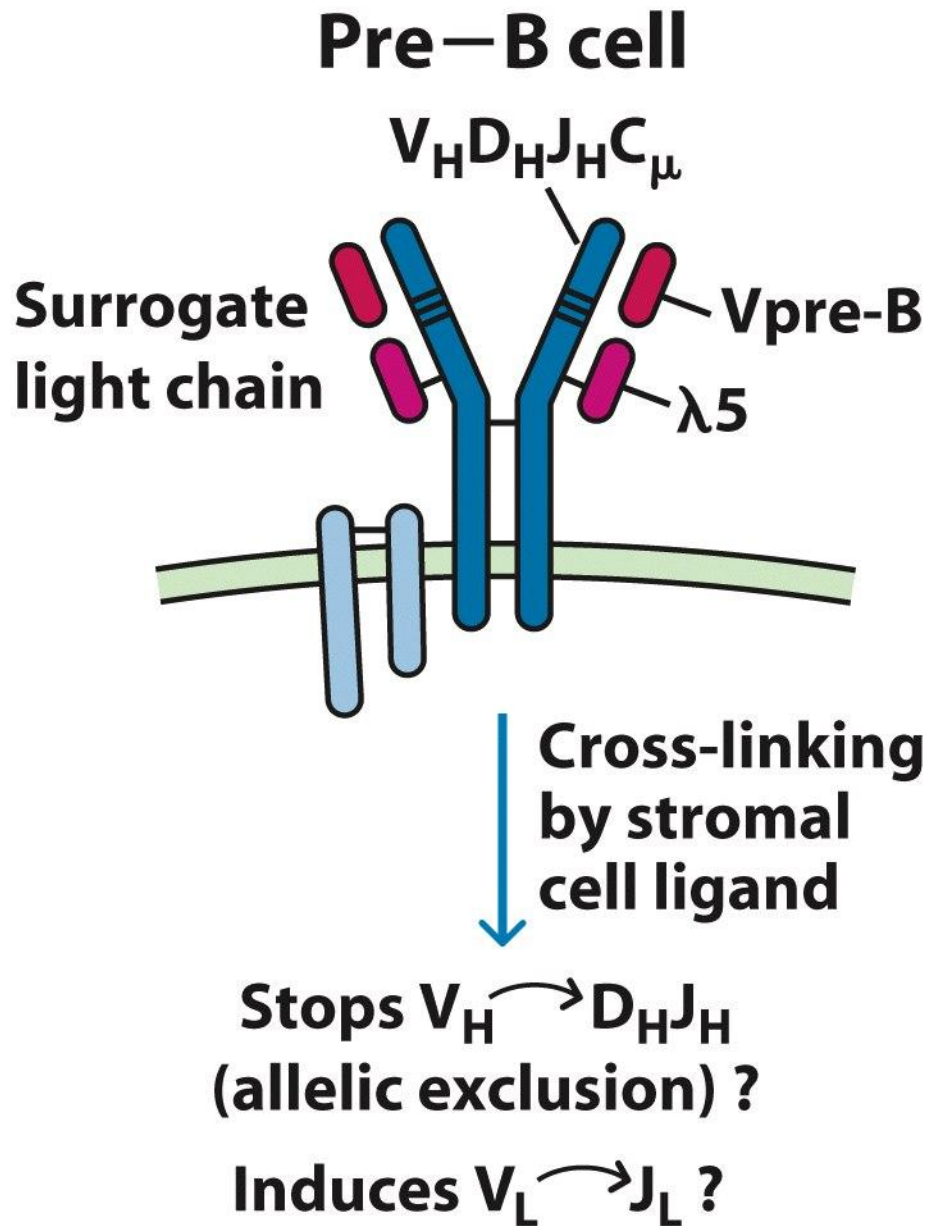

Figure 11-4 part 2
Kuby IMMUNOLOGY, Sixth Edition
 © 2007 W. H. Freeman and Company

Stages in B-cell maturation in the bone marrow

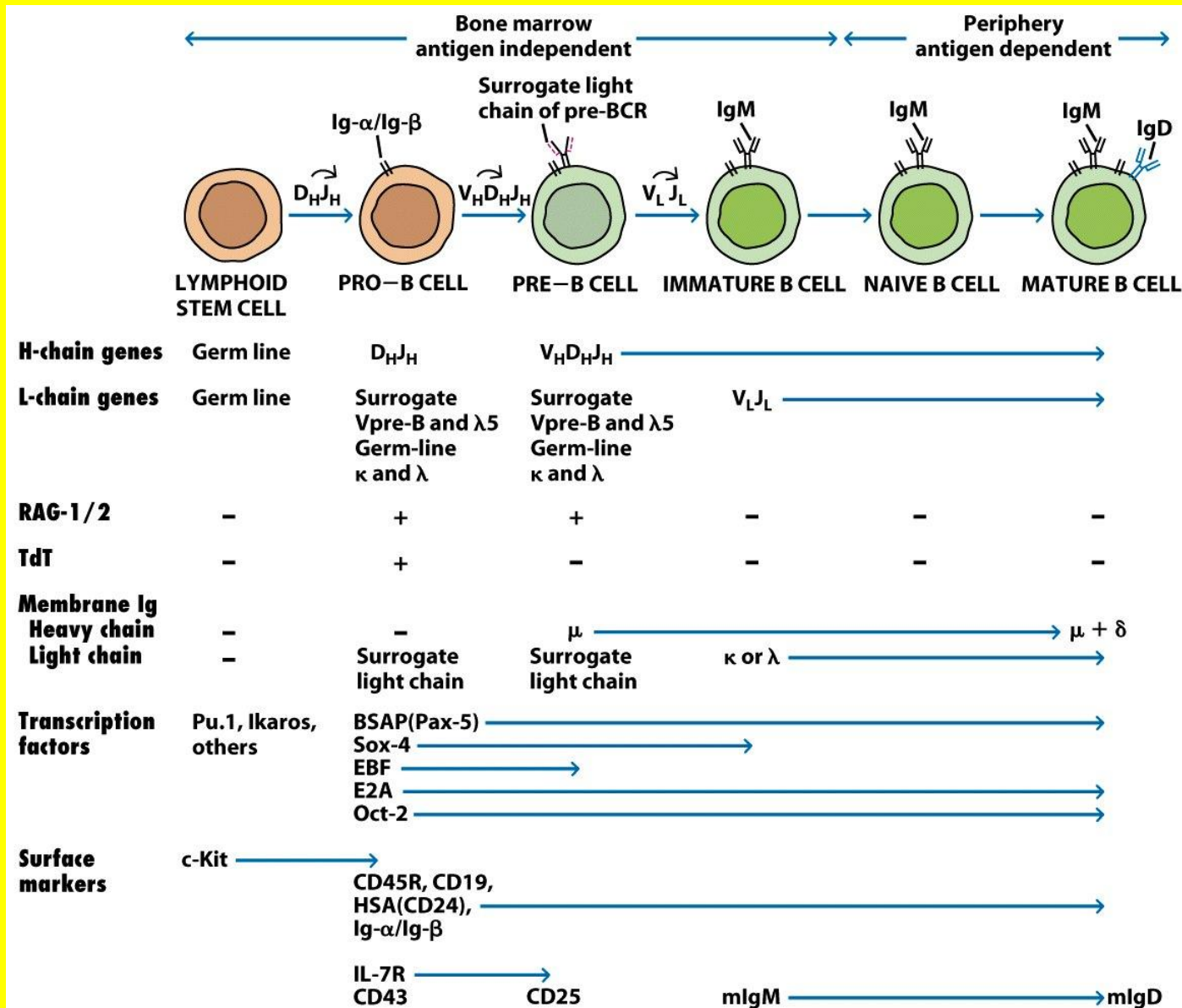

Figure 11-3
Kuby IMMUNOLOGY, Sixth Edition

Ig α and Ig β are Signaling Subunits of the B Cell Receptor (BCR; surface Ig molecule)

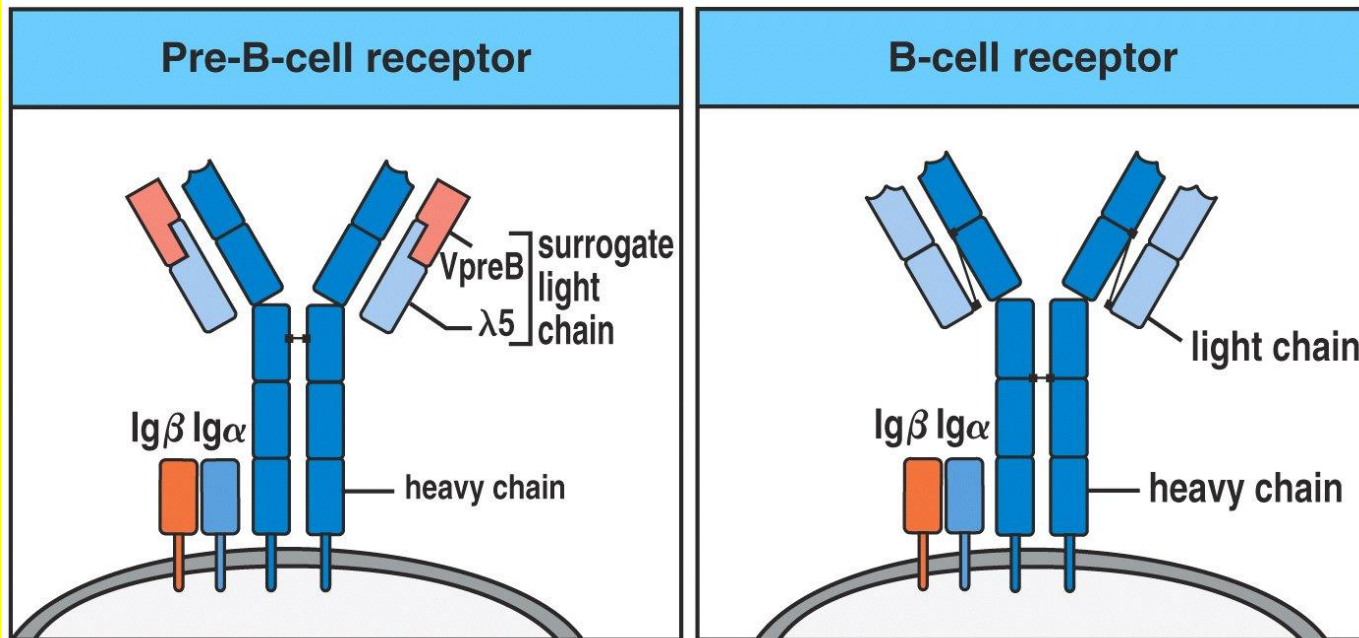

Figure 4-4 The Immune System, 2/e (© Garland Science 2005)

Notes

1. The Ig molecule (either pre-BCR or BCR) can not travel to the surface of the B cell without Ig α and Ig β
2. The pre-BCR and BCR consist of an Ig molecule plus Ig α and Ig β
3. Ig α and Ig β genes turned on at the pro-B-cells stage and remain on until cell becomes an antibody secreting plasma cell
4. Ig α and Ig β send signals when receptors are engaged (bound antigen)

Peripheral or Secondary lymphoid tissues

- **Trap antigen-bearing dendritic cells**
- **Initiation of adaptive immune response**
- **Provide signals that sustain recirculating lymphocytes**

Lymph Nodes

- **Sites of Immune responses**
- **Encapsulated bean-shaped structures, reticular network, full of lymphocytes, macrophages, and dendritic cells.**
- **First organized lymphoid structure to encounter antigens-reticular structures trap antigen**

Lymph Nodes

- **Cortex**
 - Contains mostly B cells, macrophages and follicular dendritic cells
- **Paracortex**
 - Primarily T lymphocytes, and dendritic cells
- **Medulla**
 - Sparsely populated with lymphoid lineage cells (mostly plasma cells)

Where are these lymph nodes?

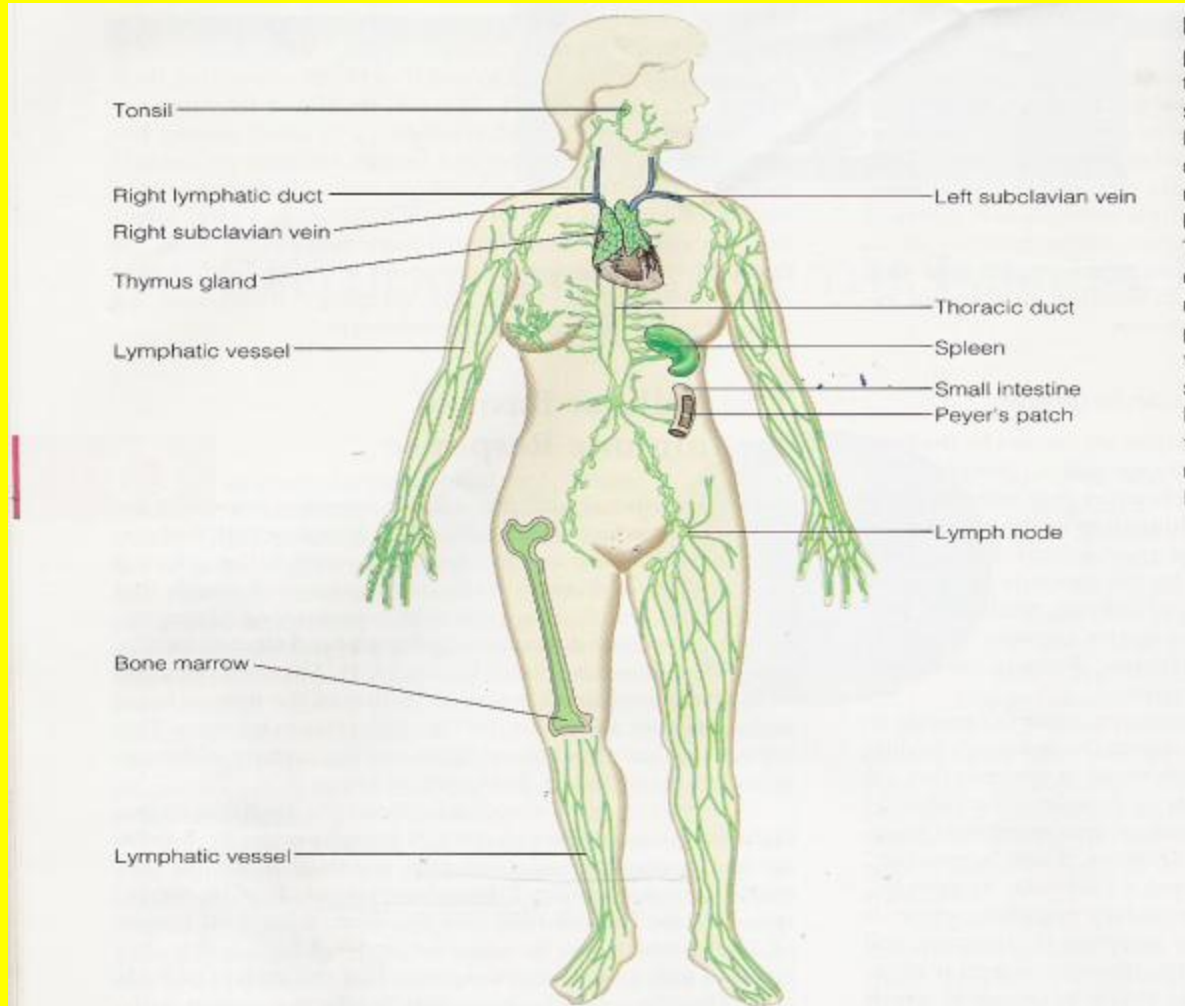

Lymph Nodes

- Range from 1–25 mm diameter

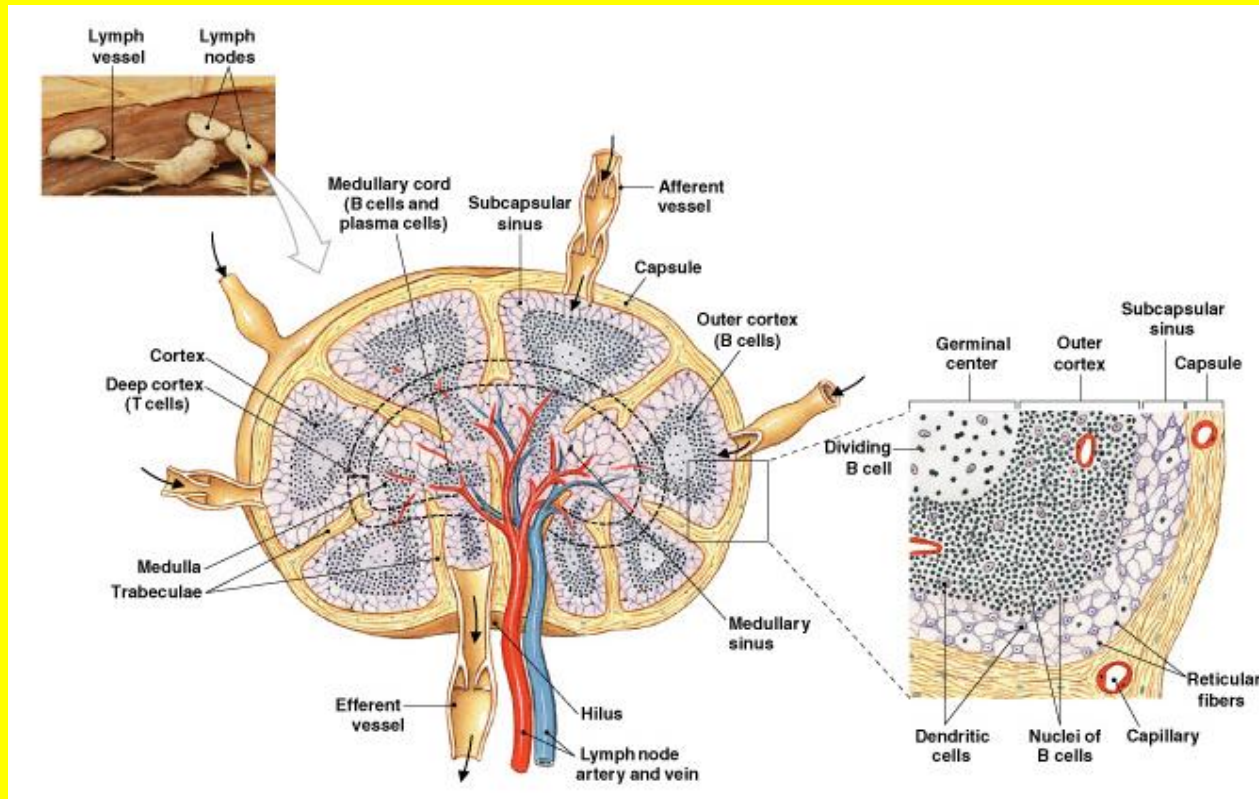

Figure 22-7

Lymphatic System: Anatomy

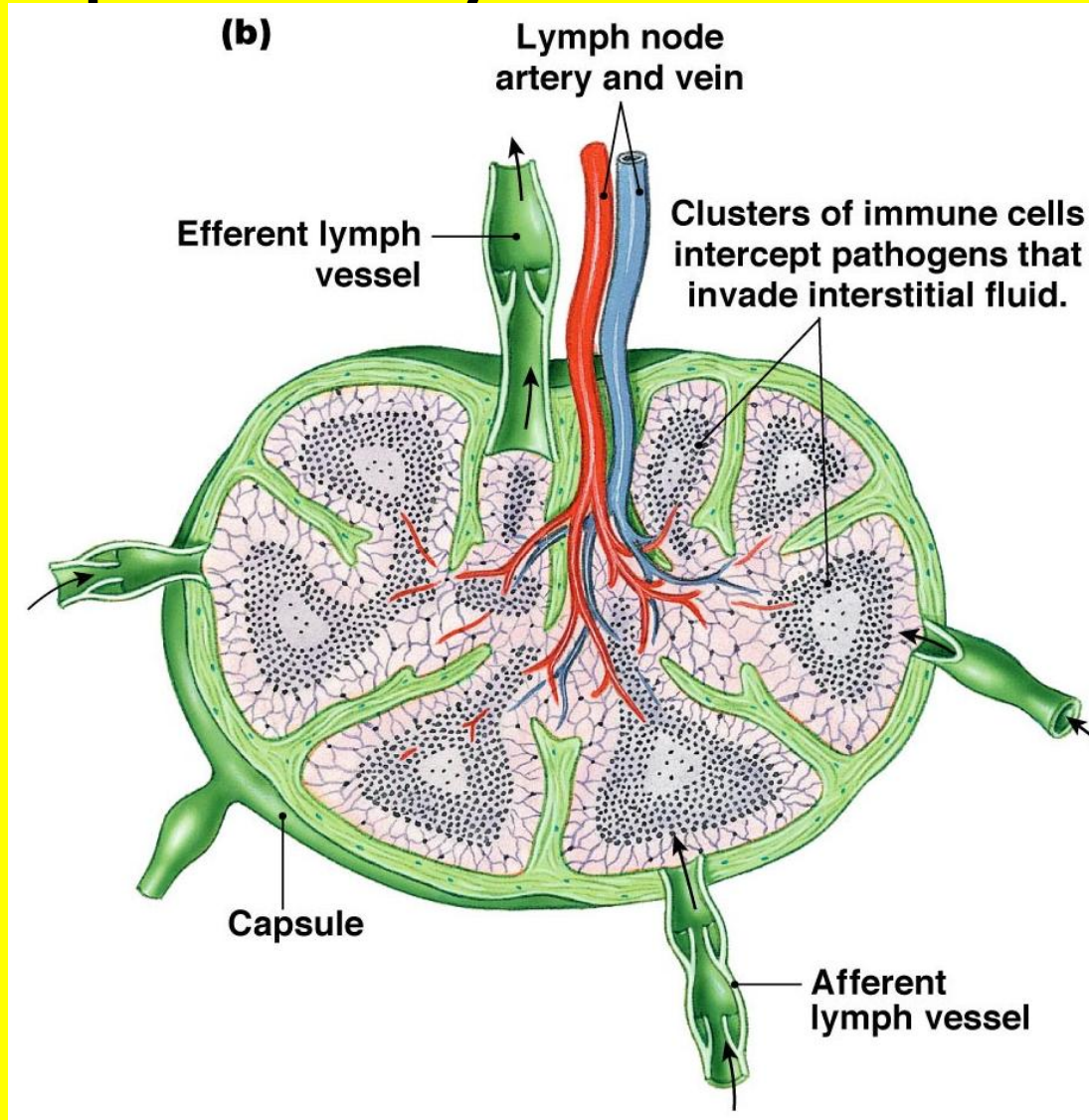
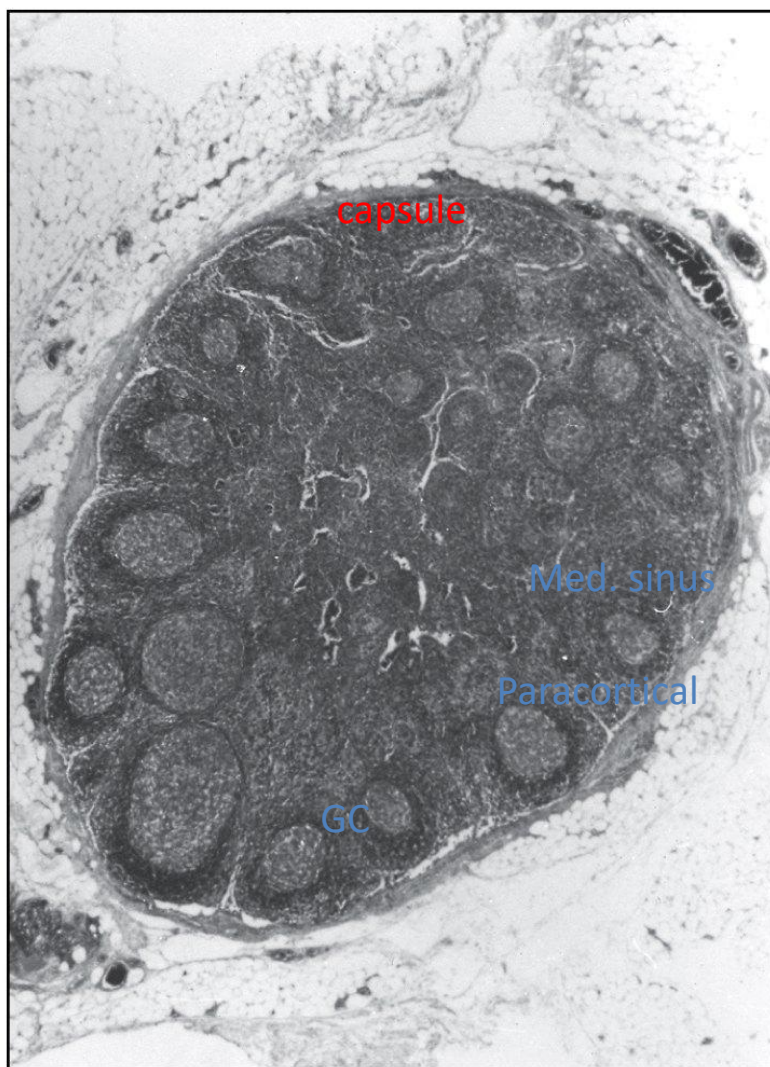

Figure 24-2b

Structure/function of the Lymph Node



Germinal center foci
Reach maximum
Size within 4 to 6
days of antigen
challenge.

Figure 1-8 part 2 of 2 Immunobiology, 6/e. (© Garland Science 2005)

Spleen

- **Major role in mounting immune responses to antigens in the bloodstream**
 - **Filters blood and traps antigens**

- **Not supplied with lymphatic vesicles**
 - **Splenic artery carries antigens and lymphocytes**

Structure of the Spleen

- **Surrounded by a capsule from which a number of trabeculae extend into interior (compartmentalized structure)**

Structure of the Spleen

- **Spenic red pulp consists of a network of sinusoids**
 - **Populated by macrophages, RBCs, and a few lymphocytes**
 - **Site where old and defective RBCs are destroyed and removed**
 - **Macrophage engulf RBCs**

Structure of the Spleen...

- **Splenic white pulp surrounds the branches of the splenic artery**
 - **Forms periarteriolar lymphoid sheath (PALS), populated primarily by T cells.**
 - **Primary lymphoid follicles are attached to the PALS, are rich in B cells and some contain germinal centers**
 - **Marginal zone, peripheral to the PALS, is populated by lymphocytes and macrophages**

Spleen

1. The site of immune responses to blood Ags
=> **A filter of blood**

2. **White pulp** => T cell & B cell zones

Marginal zone (MZ)

Red pulp (RP)

3. T cells => periarteriolar lymphoid sheaths

B cells => follicle

=> marginal zone

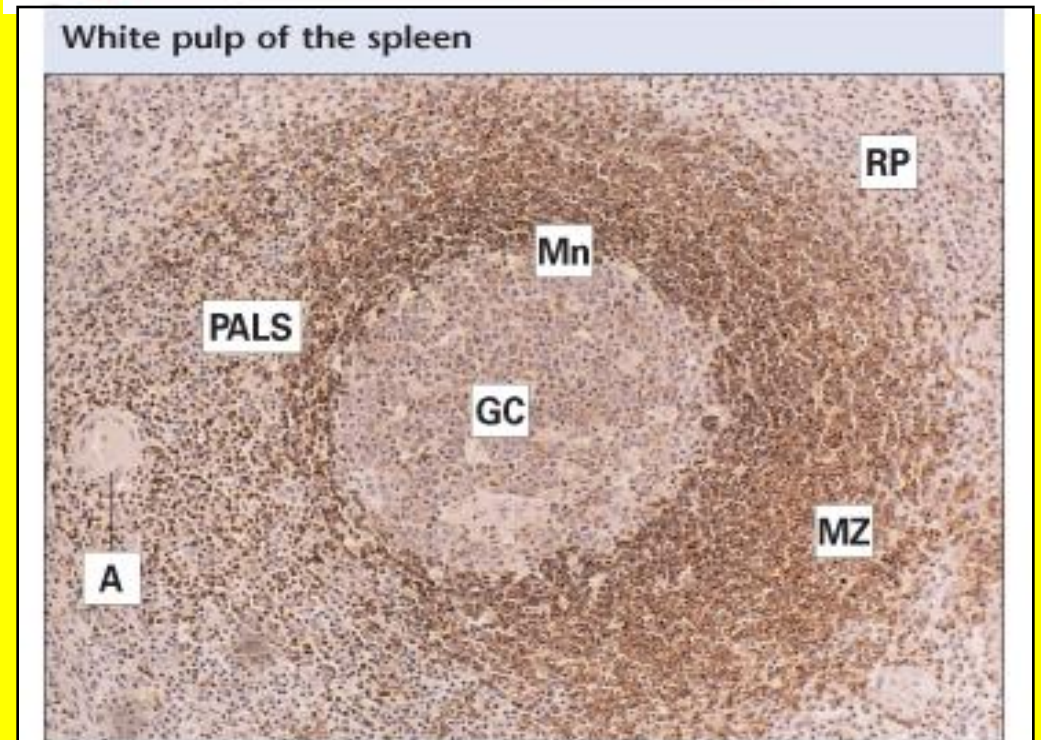
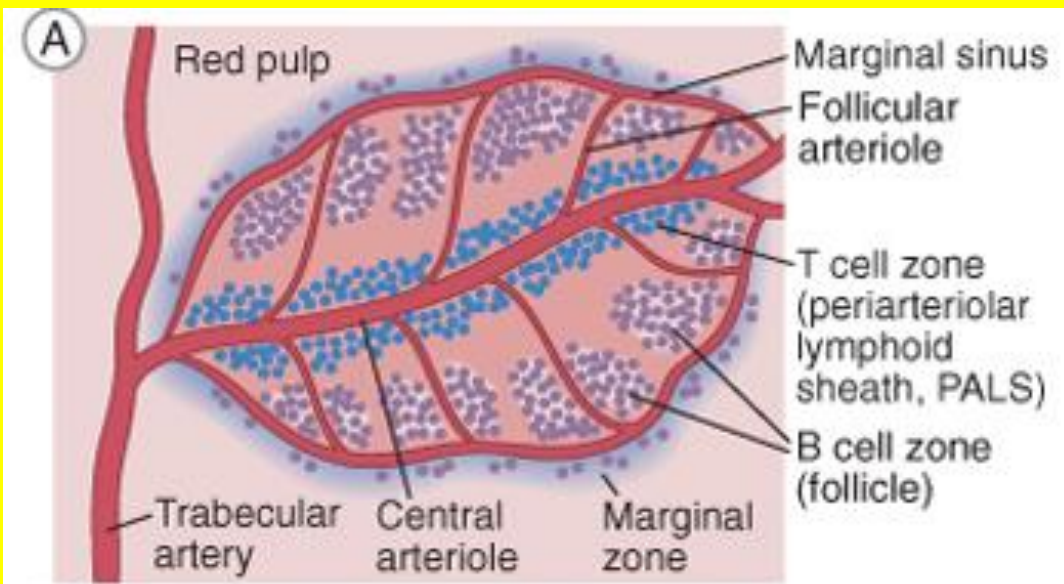

Organization of a germinal center in the spleen

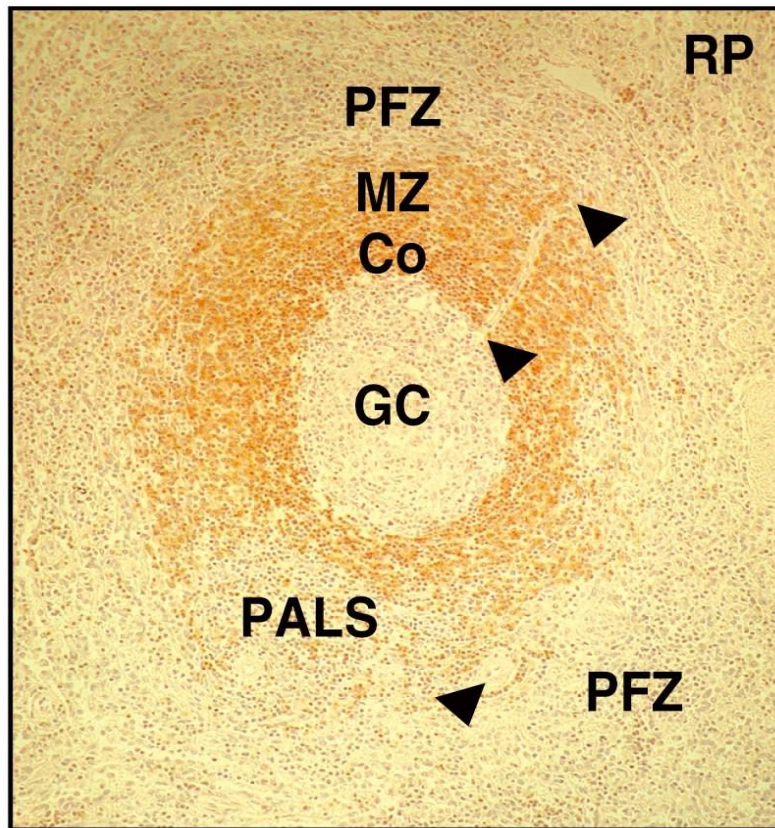

- **PFZ-perifollicular zone**
- **PALS-periarteriolar lymphoid sheath**
- **Co-follicular B-cell corona**
- **MZ-marginal zone**
- **RP-red pulp**

Figure 1-9 part 3 of 3 Immunobiology, 6/e. (© Garland Science 2005)

Loss of spleen (splenectomy)

- **Severity depends on age**
- **In children, splenectomy often leads to increased incidence of bacterial sepsis**
- **Few adverse effects in adults, can lead to some increase in blood-borne bacterial infections (bacteremia)**

MALT or Mucosa-assoc. Lymphoid Tissue

- **Mucous membranes lining digestive, respiratory and urogenital system are the major sites of entry for most pathogens.**

BALT -Bronchus-associated (respiratory)

GALT-gut-associated (digestive tract)

MALT...

- **Have different organizations.**
 - Peyer's patches in intestinal lining well organized
 - Barely organized clusters of lymphoid cells in lamina propria of intestinal villi
 - Tonsils
 - appendix
- **Large nos. of plasma cells (more than in the spleen and lymph Nodes)**

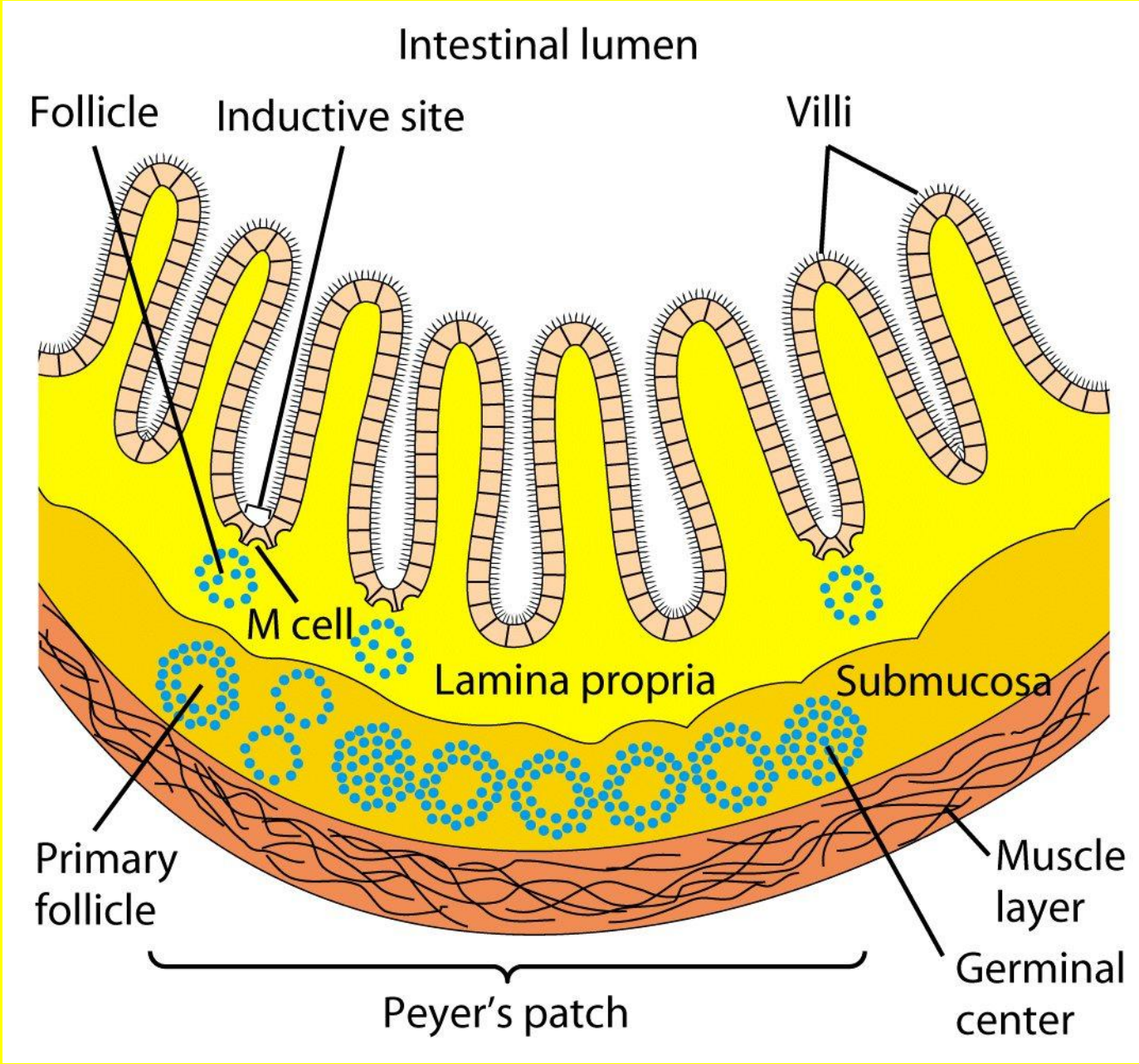

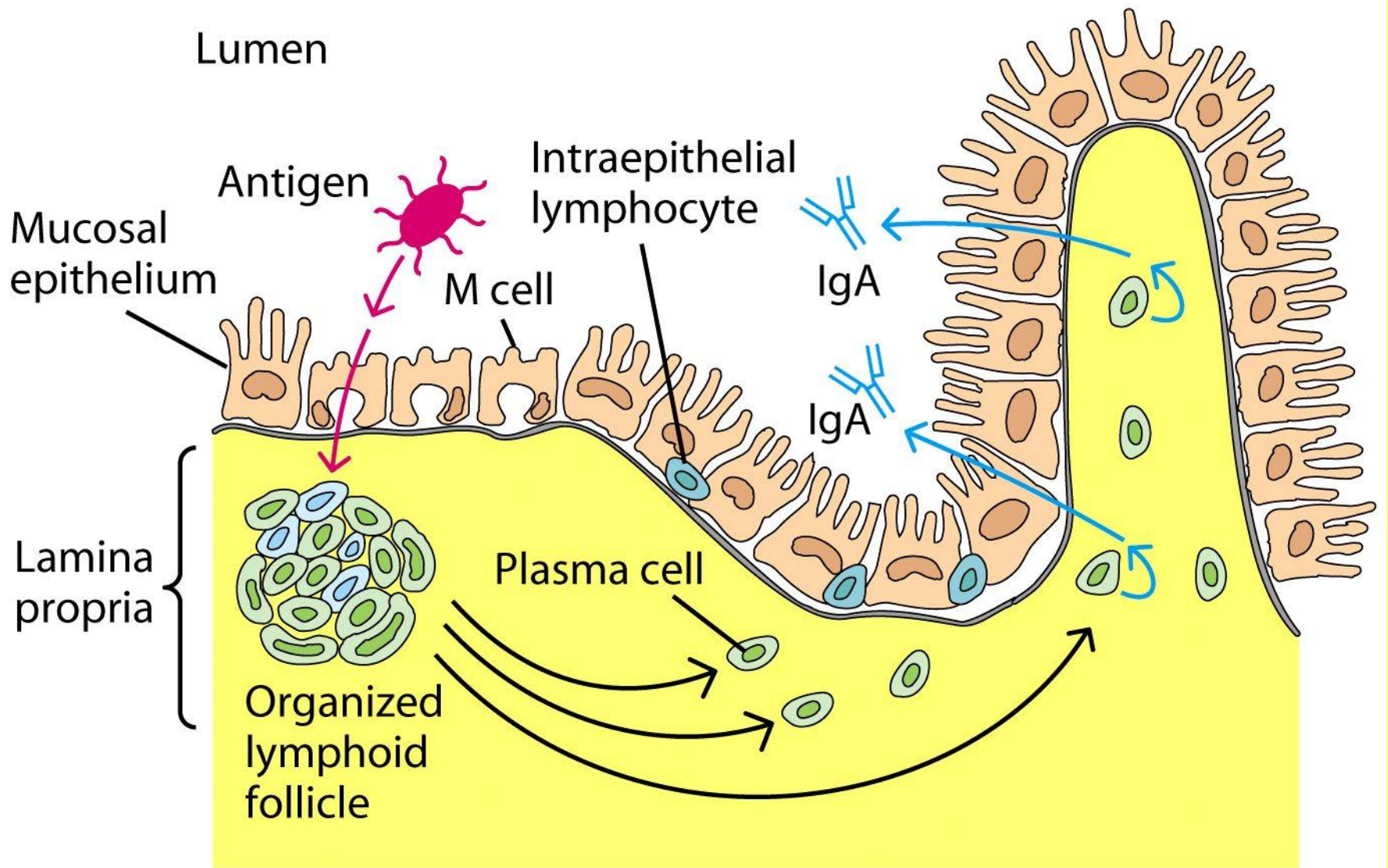

M Cells.

Have a deep invagination or pocket, in the basolateral plasma membrane, which is filled with a cluster of B cells, T cells and Macrophage.

Antigens in intestinal lumen are endocytosed into vesicles and Transported from the luminal membrane to underlying pocket Membrane

Vesicles fuse with the pocket membrane, delivering antigens To lymphocytes and macrophage

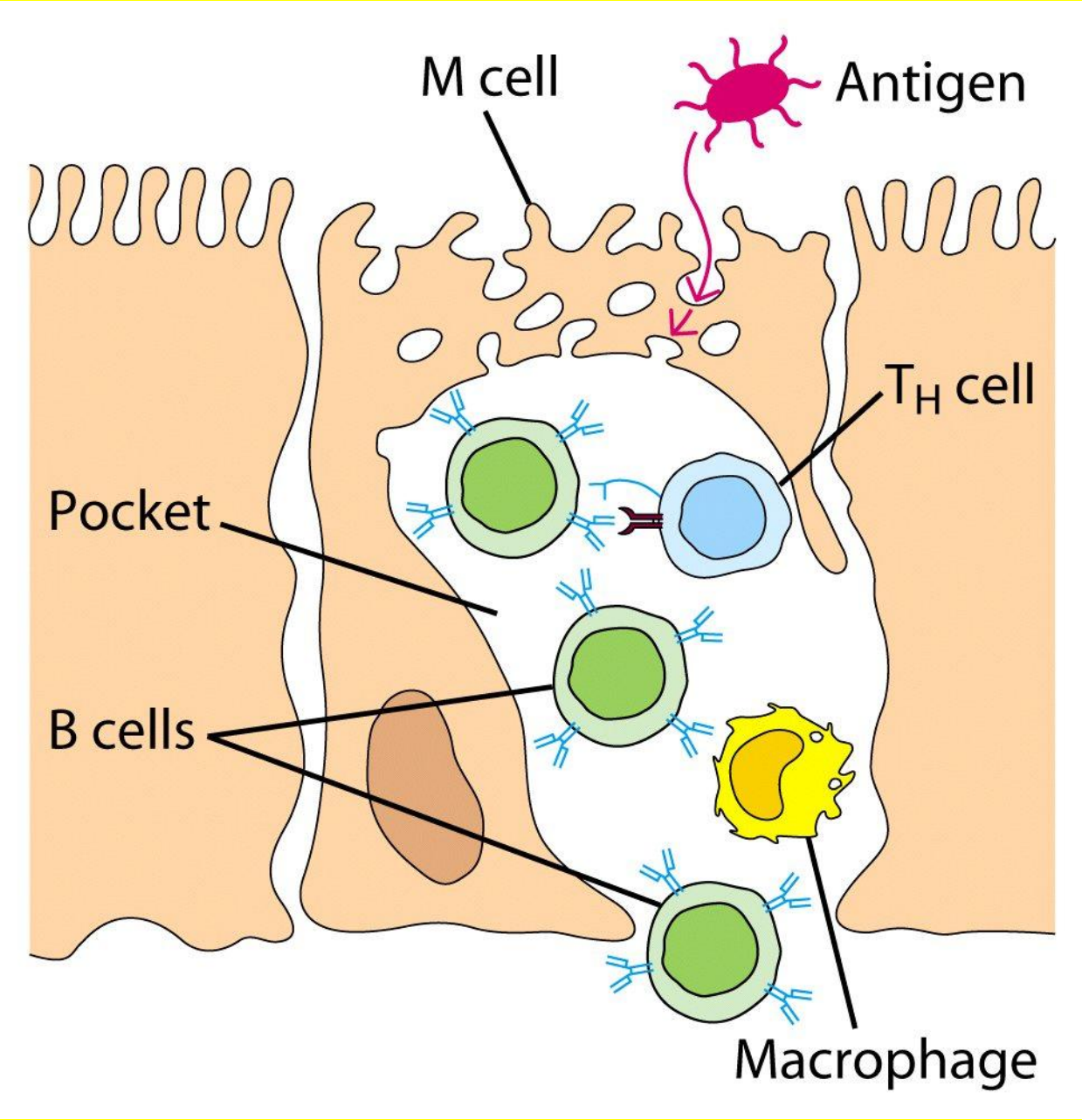

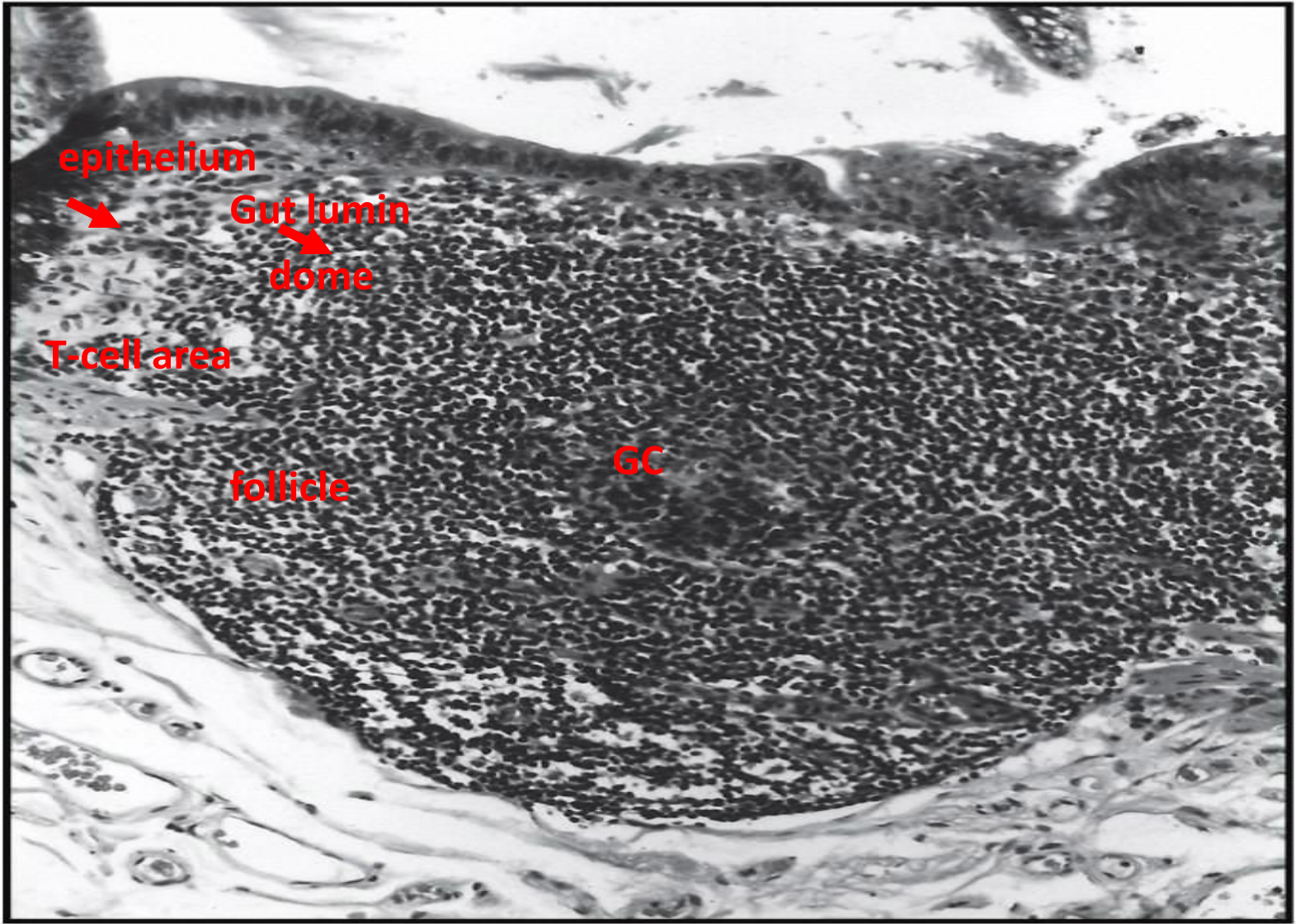

epithelium



Gut lumen

dome



T-cell area

follicle

GC

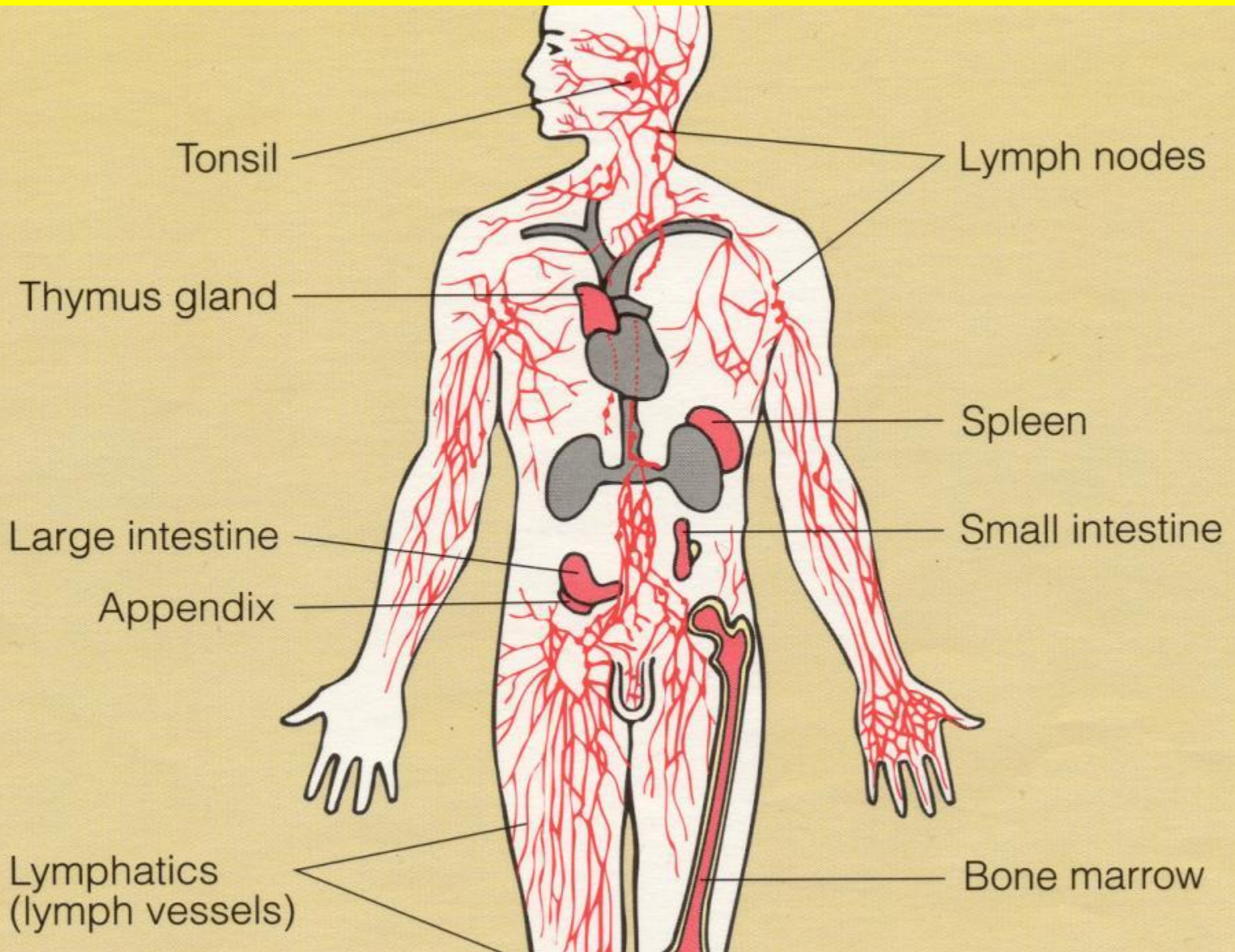

Lymphoid Nodules

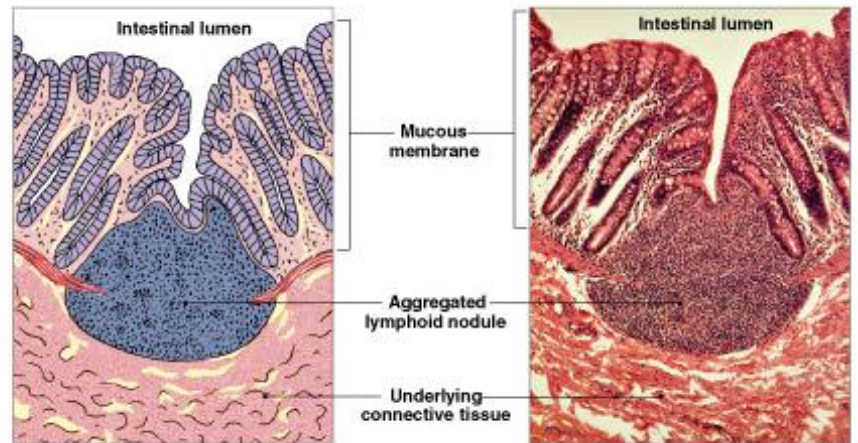

(a) Aggregated lymphoid nodule (intestinal tract)

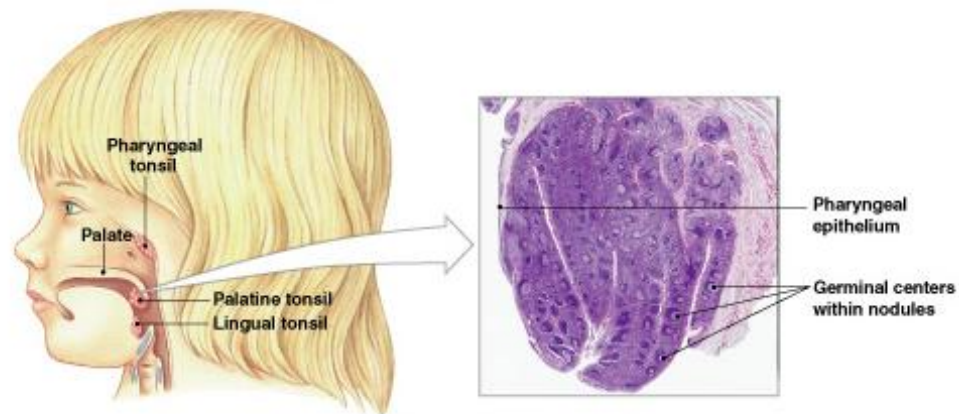

(b) Pharyngeal tonsil (respiratory tract)

Jobs of Lymphatic System:

Lymphatic System which consists of vessels and organs plays **two vital roles** in our lives:

- 1) The vessels essentially maintain interstitial fluid levels by **carrying excess fluids as well as any plasma proteins, back into the CVS.**
- 2) The organs, house critical immune cells such as lymphocytes which carryout our **body defense against infection and disease as well as offer ACQUIRED IMMUNITY.**

Lymphatic Characteristics

- **Lymph** – excess tissue fluid carried by lymphatic vessels (general definition)
- **Properties of lymphatic vessels**
 - One way system toward the heart
 - No pump
 - Lymph moves toward the heart
 - Milking action of skeletal muscle
 - Rhythmic contraction of smooth muscle in vessel walls

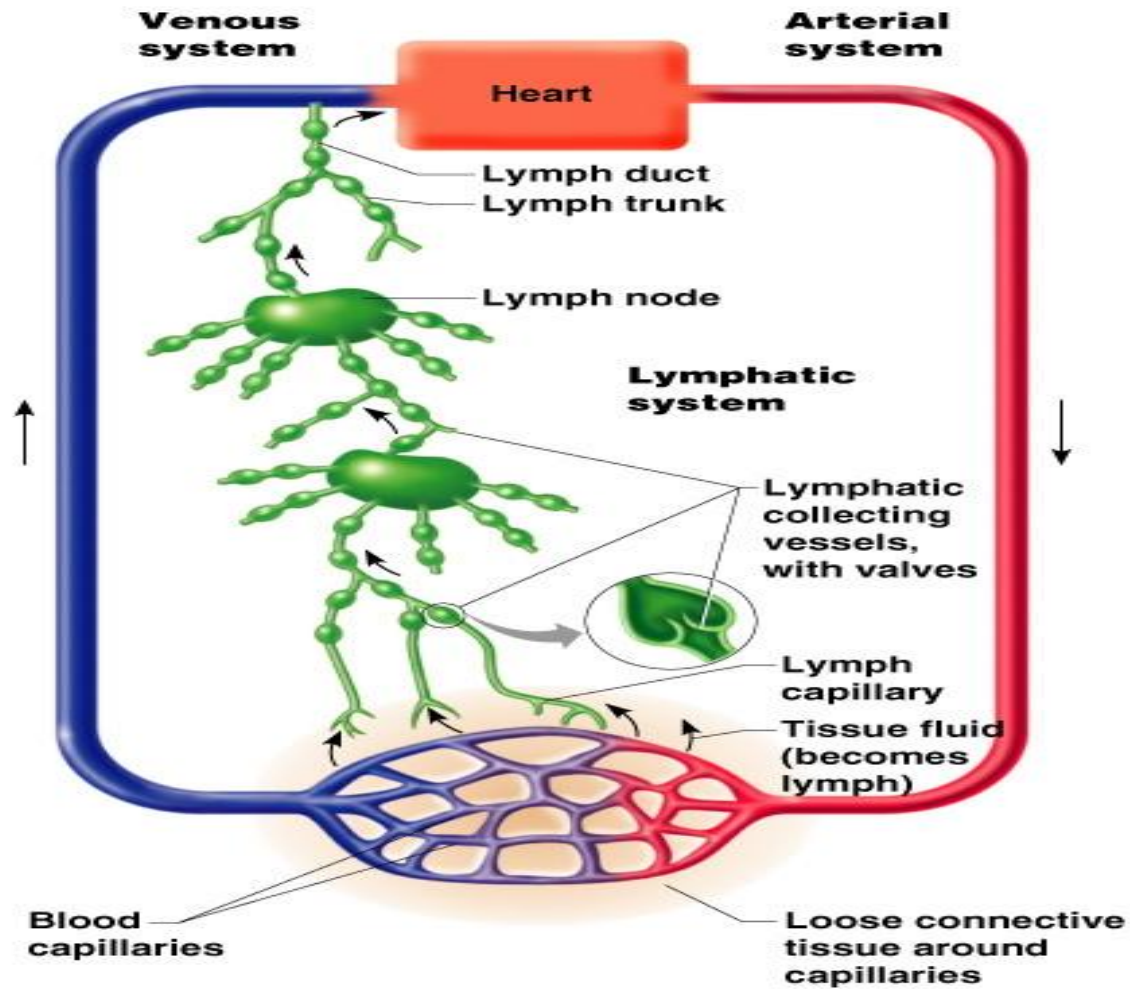

Composition of Lymph

- Lymph is usually a clear, colorless fluid, similar to blood plasma but low in protein
- Its composition varies from place to place; after a meal, for example, lymph draining from the small intestine, takes on a milky appearance, due to lipid content.
- Lymph may contain macrophages, viruses, bacteria, cellular debris and even traveling cancer cells.

What Type of Vessels Make up the Lymphatic System?

- The vessels are called lymphatics.
- They are thin-walled and are analogous to veins.
- Small lymphatics are similar to capillaries only more porous; Larger vessels are called collecting vessels: both have valves.
- 2 large Ducts: Right **LYMPHATIC DUCT** and **THORACIC DUCT (BOTH EMPTY INTO THE RT AND LT SUBCLAVIAN VEINS)**
- Lymph flows only **TO THE HEART (ONE WAY)**.
- This is a **low-pressure, pumpless system**. Lymph moves via skeletal muscles and pressure changes in thorax during breathing only.

CIRCULATION IN THE LYMPH VESSELS

Lymph vessels do not have a central pump equivalent to the heart. Their performance depends especially on their **compression** caused by adjacent muscles. A regular decrease in pressure that occurs inside the thoracic cage during inhalation makes it easy for the lymph to go up from the legs to the trunk of the body. Inside the lymph vessels, there is a **valve system** that ensures lymph circulation in just one direction and prevents its backflow.

RELATIONSHIP BETWEEN LYMPH CIRCULATION AND BLOOD CIRCULATION

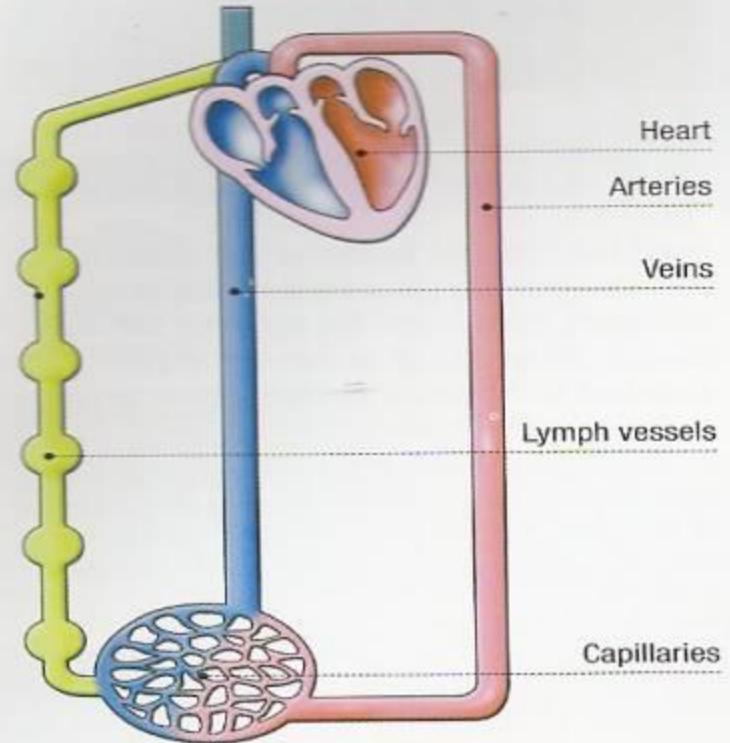

SECTION OF A LYMPH VESSEL

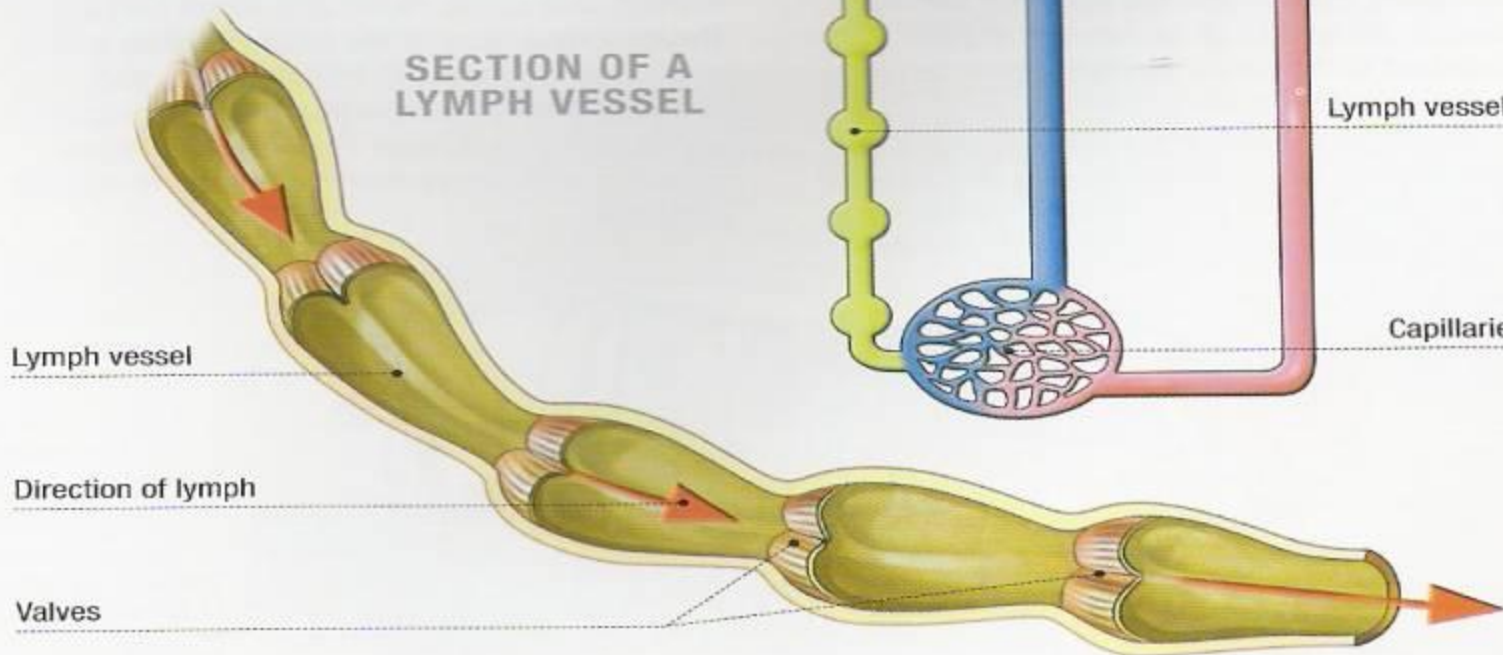

Lymph Carries ...

- Harmful materials that enter lymph vessels
 - Bacteria
 - Viruses
 - Cancer cells
 - Cell debris

EDEMA

- **Edema is the excess accumulation of fluids in tissue spaces.** This can retard normal exchange of nutrients and metabolites. Filtration of the extracellular fluid exceeds drainage. Anything that causes increased capillary pressure, such as decreased plasma protein, increased capillary **permeability or lymphatic blockage**, can result in swelling and congestion of the extravascular compartment.



Lymphatic Vessels and Valves

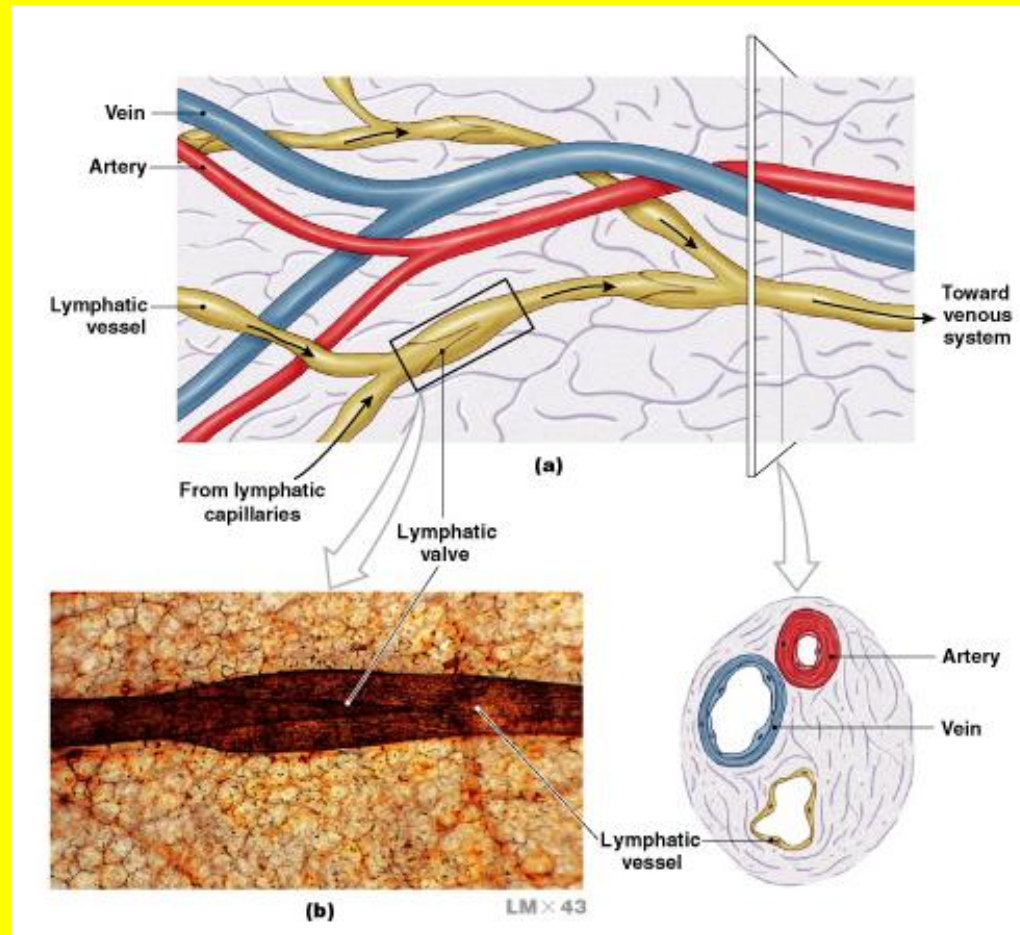

Figure 22-3

Lymphatic System

- **Blood circulates under pressure, fluid component (plasma) seeps through capillaries into surrounding tissues**
 - **Called interstitial fluid**
 - **An adult-3 liters or more per day**
 - **Returned to blood through walls of the venules (prevents edema)**
 - **Remainder of fluid enter lymphatic system**

Lymphatic System...

- **Porous architecture of lymphatic vessels (allows fluids and cells to enter)**
- **Thoracic duct = largest lymphatic vessel**
 - **Empties into L. subclavian vein (lymph from all the body except r. arm and r. side of head)**
- **Ensures steady-state levels of fluid within the circulatory system**

Lymphatic System...

- **Heart does not pump lymph**
- **Lymph flow is achieved by movements of the body's muscles**
- **Series of one-way valves produces one-way movement through vessels**
- **Foreign antigen is picked up by the lymphatic system and carried to lymph nodes**

Circulation of lymphocytes in response to infection

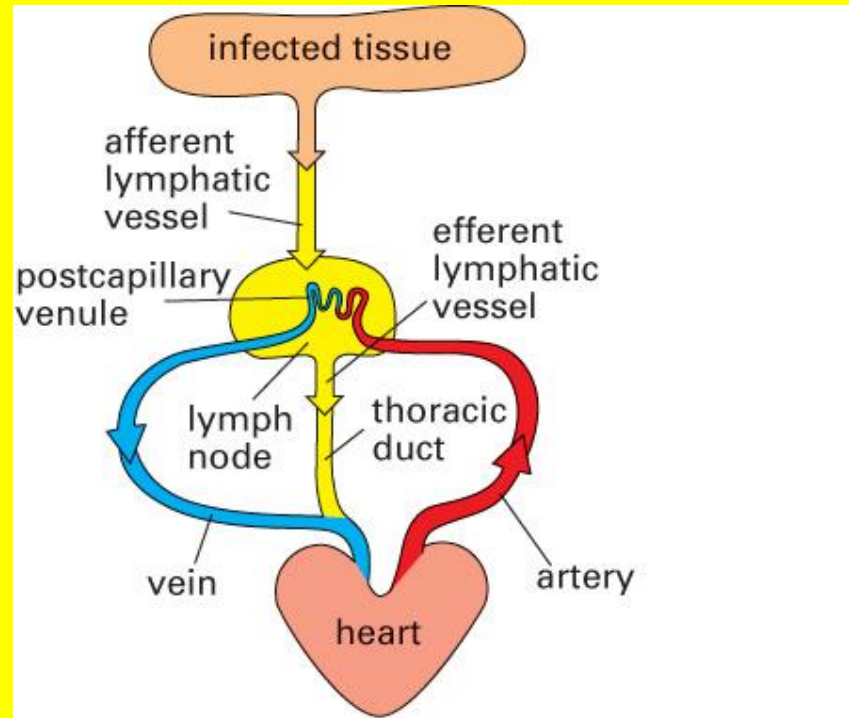
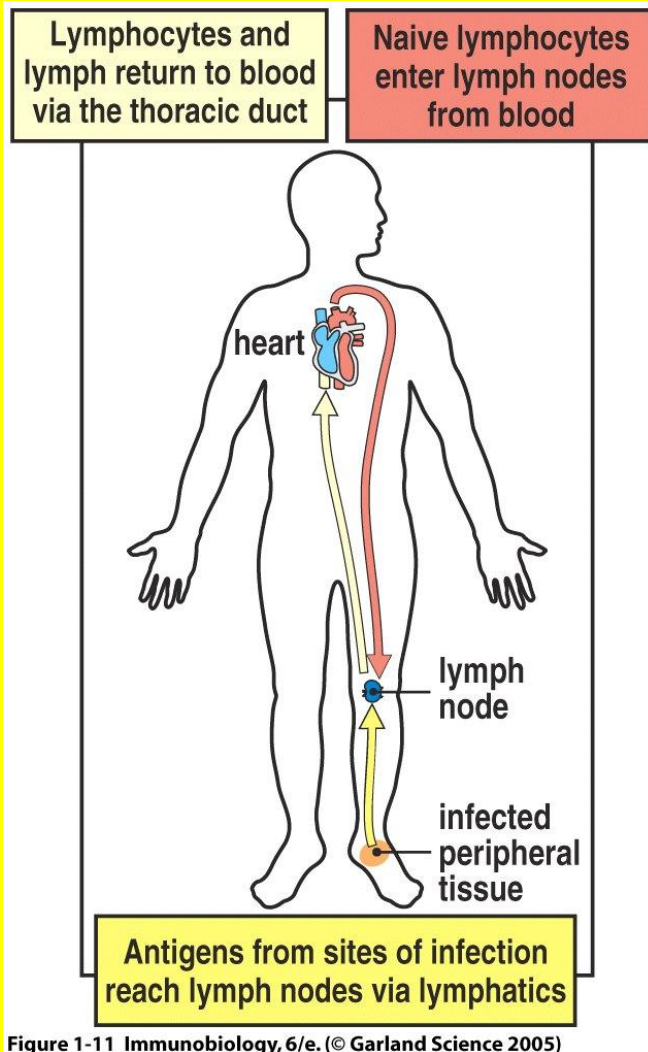

Figure 24-14. Molecular Biology of the Cell, 4th Edition.